

9005M
9005EM
1600X850X2150mm

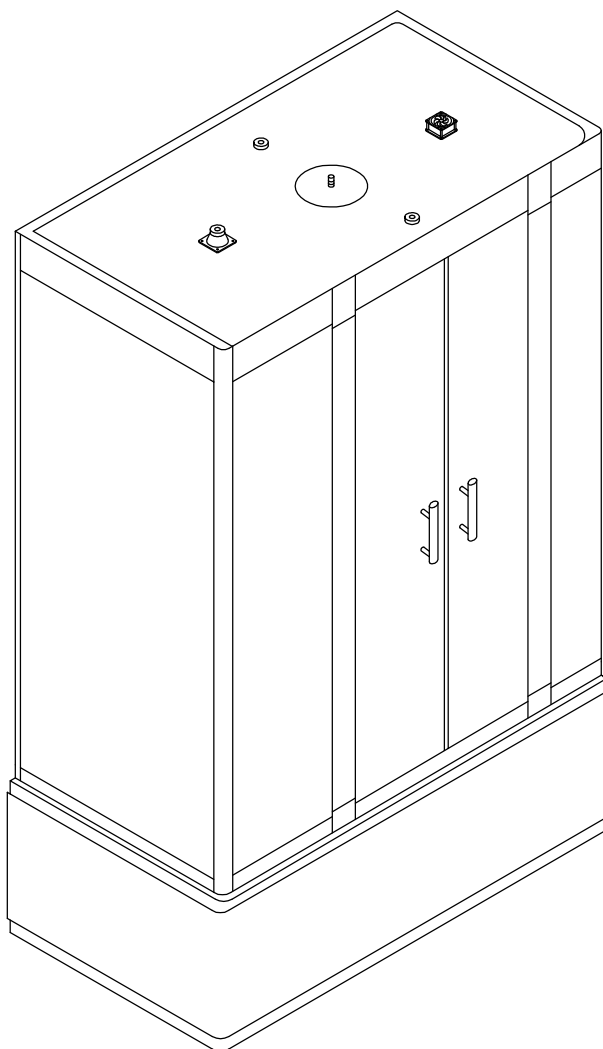

1/4

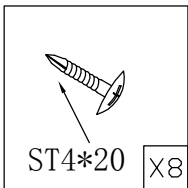
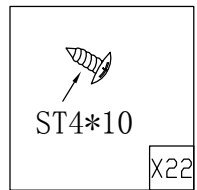
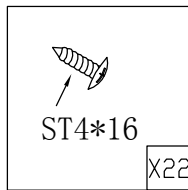
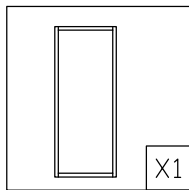
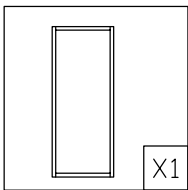
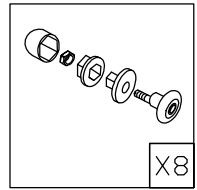
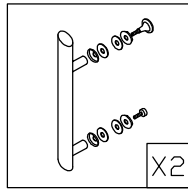
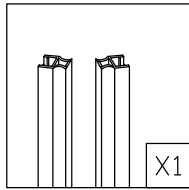
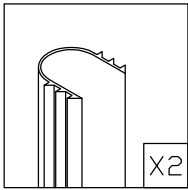
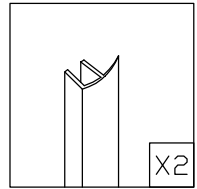
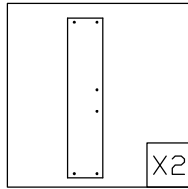
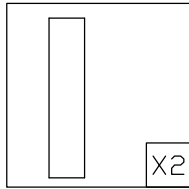
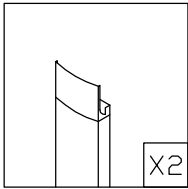
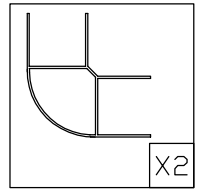
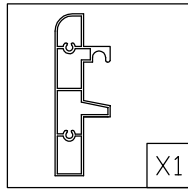
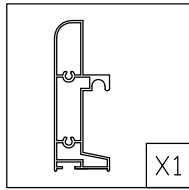
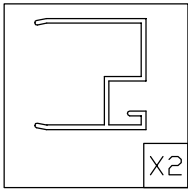
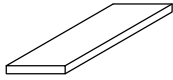
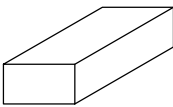

2/4 

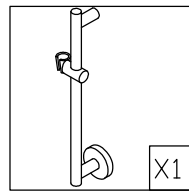
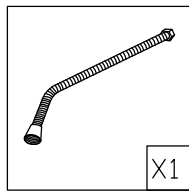
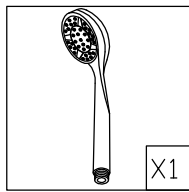
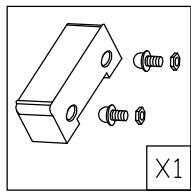
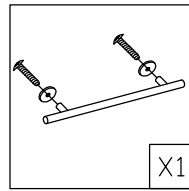
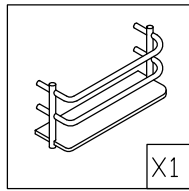
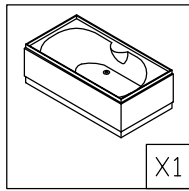
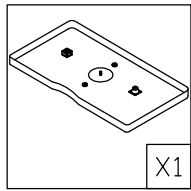

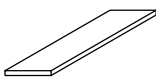
3/4 

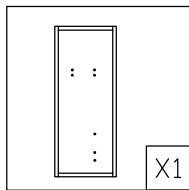
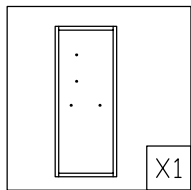

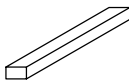
4/4 

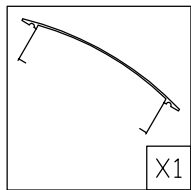

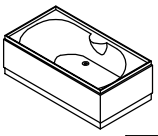

X1

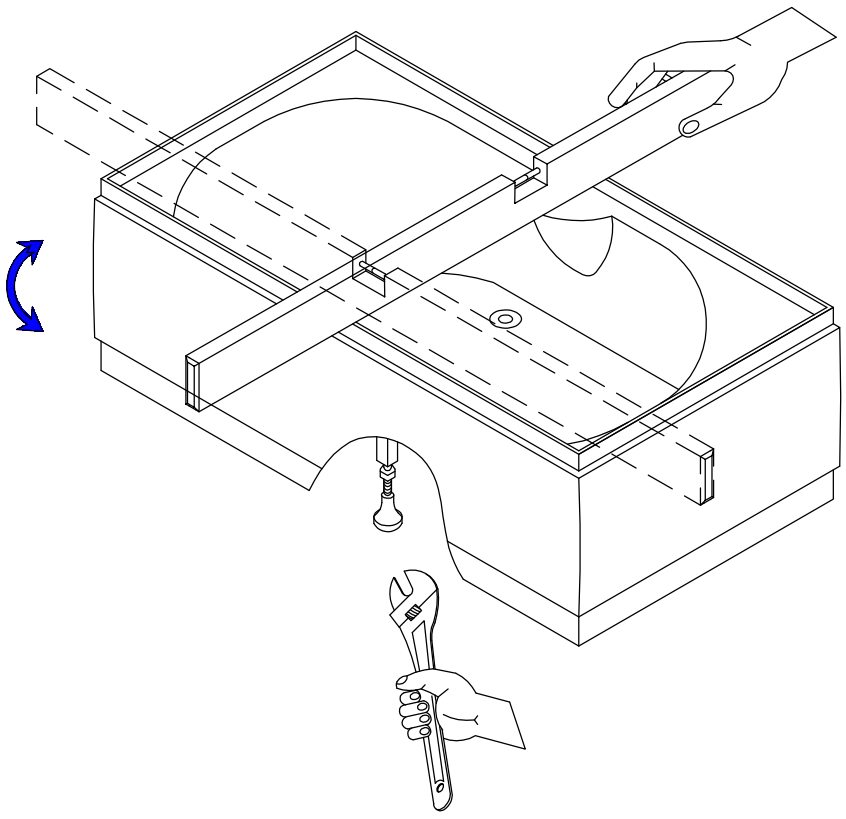
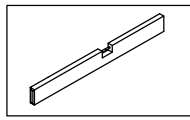
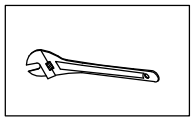

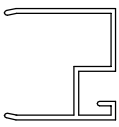

X2

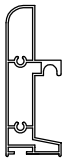

X1



X1



ST4*16

X8

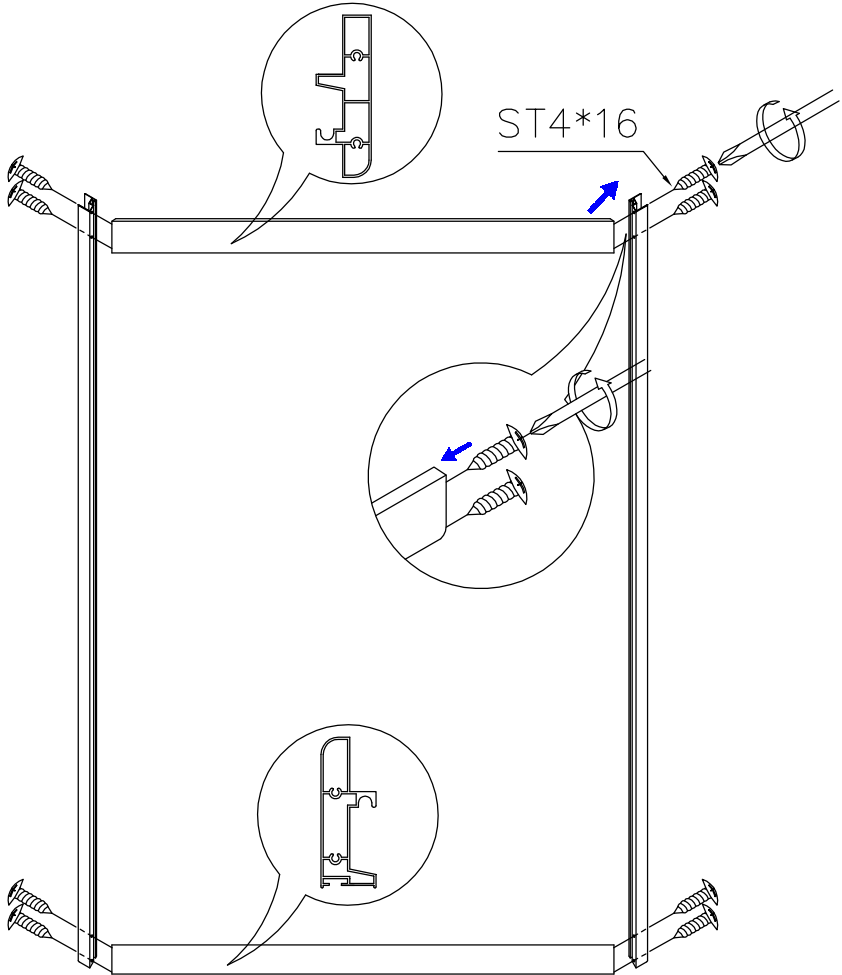

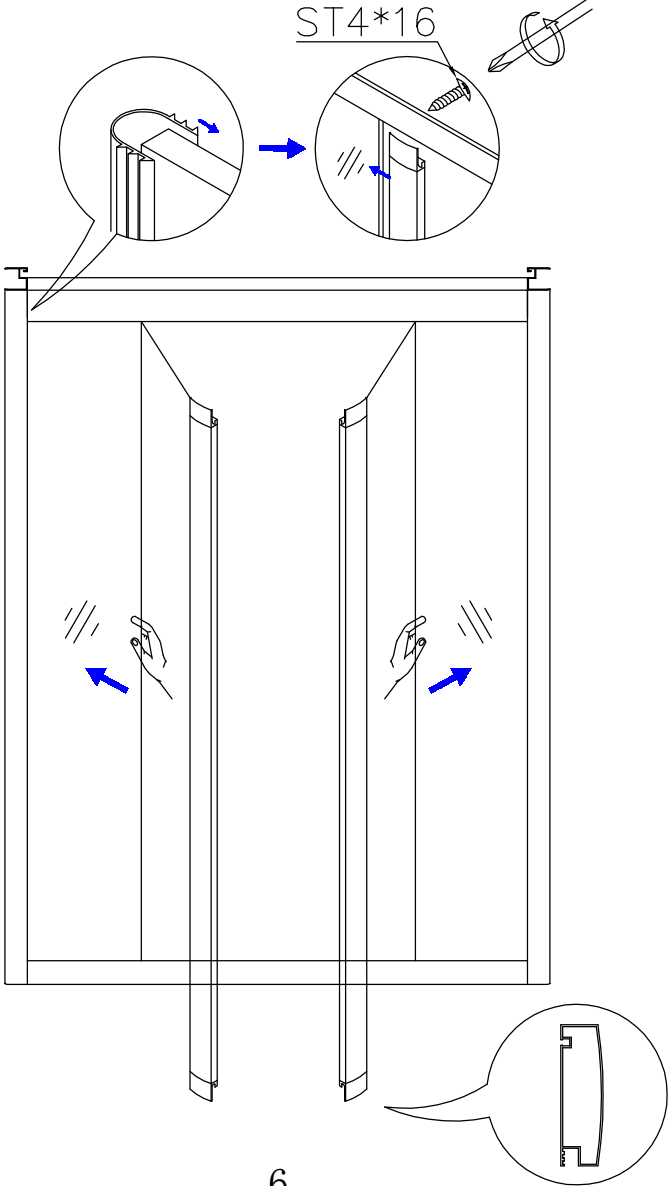
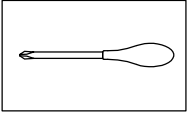
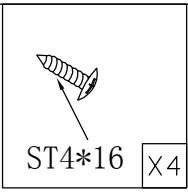
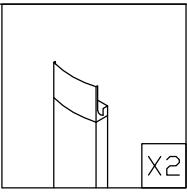
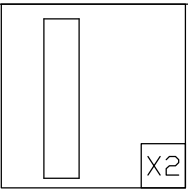
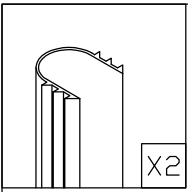

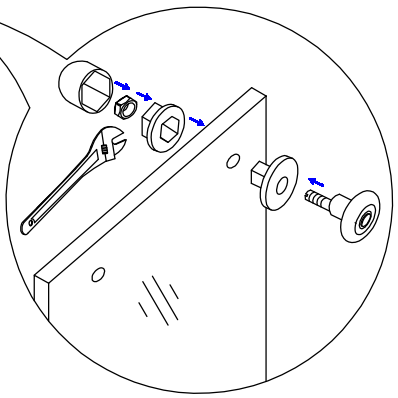
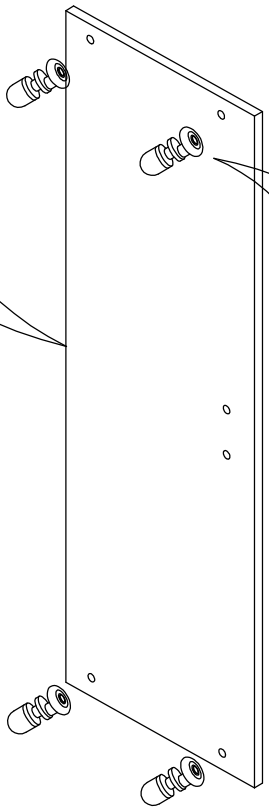
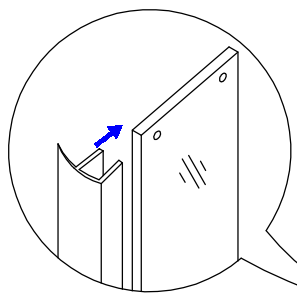
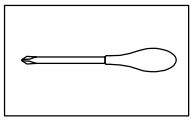
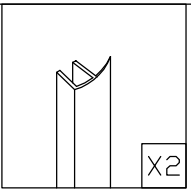
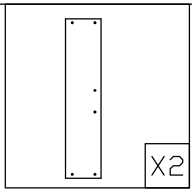
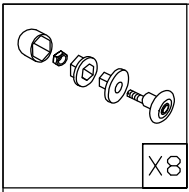

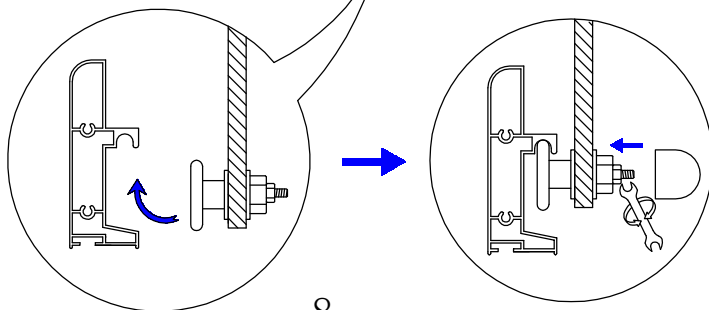
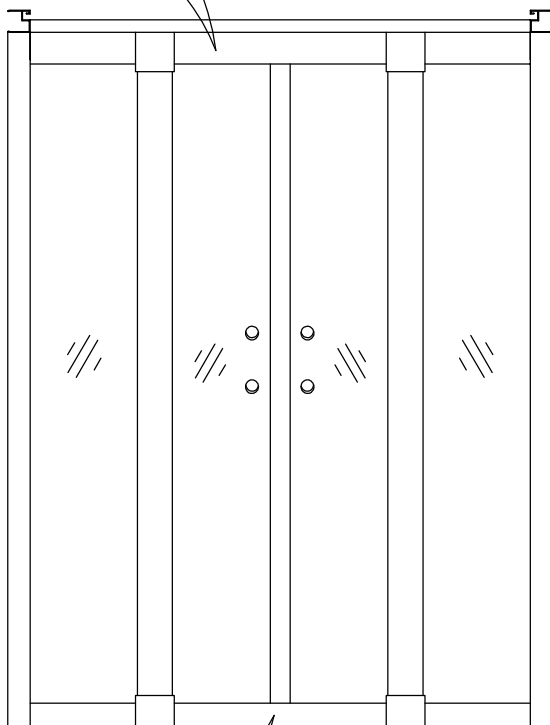
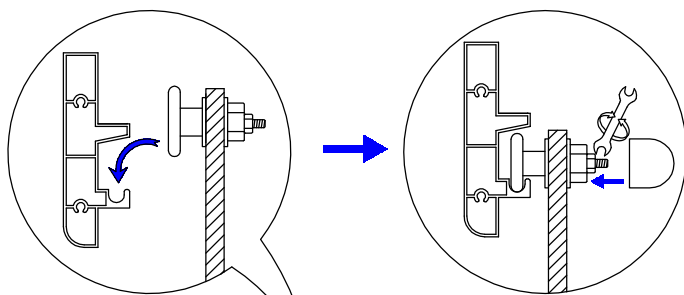

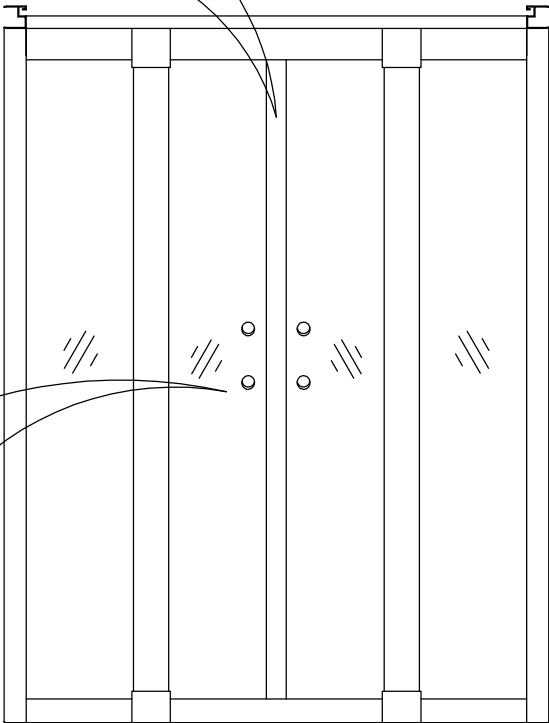
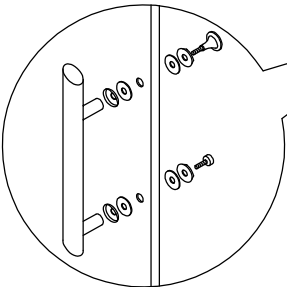
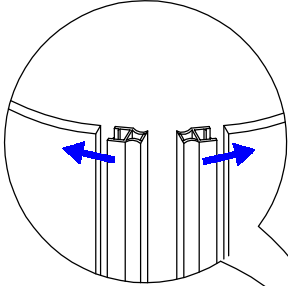
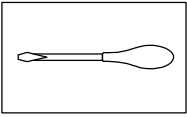
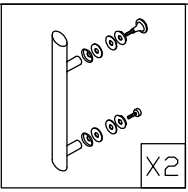
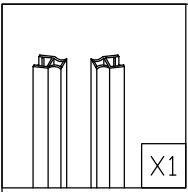

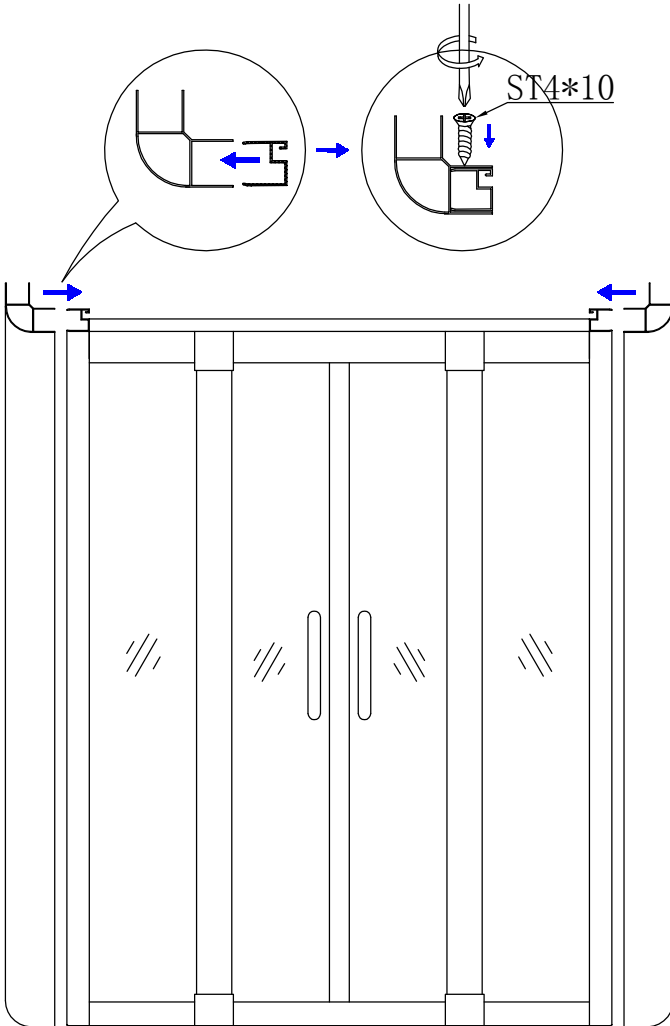
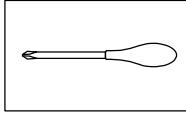
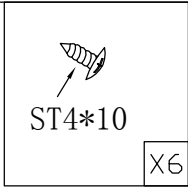
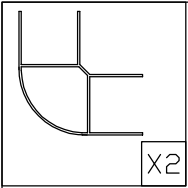

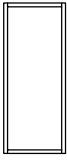

X1



X1



ST4*10

X6

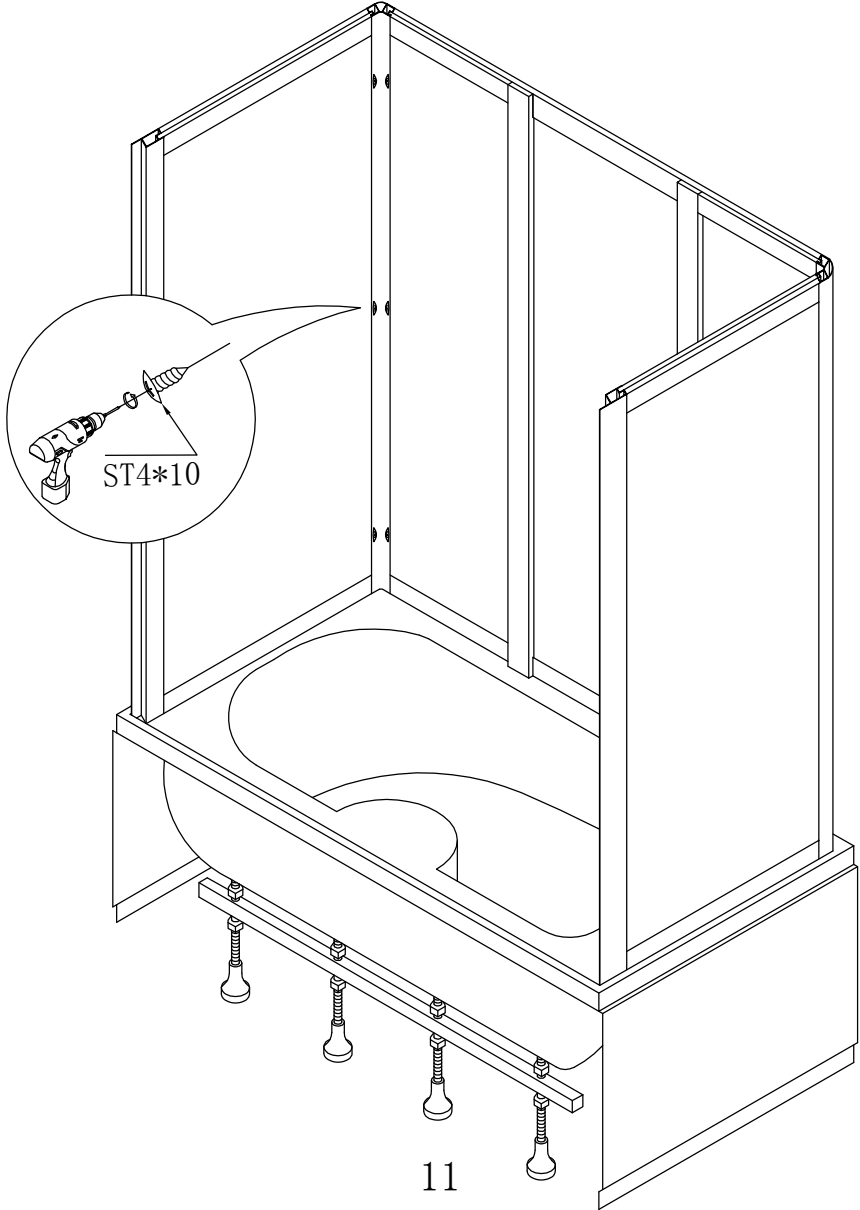

11

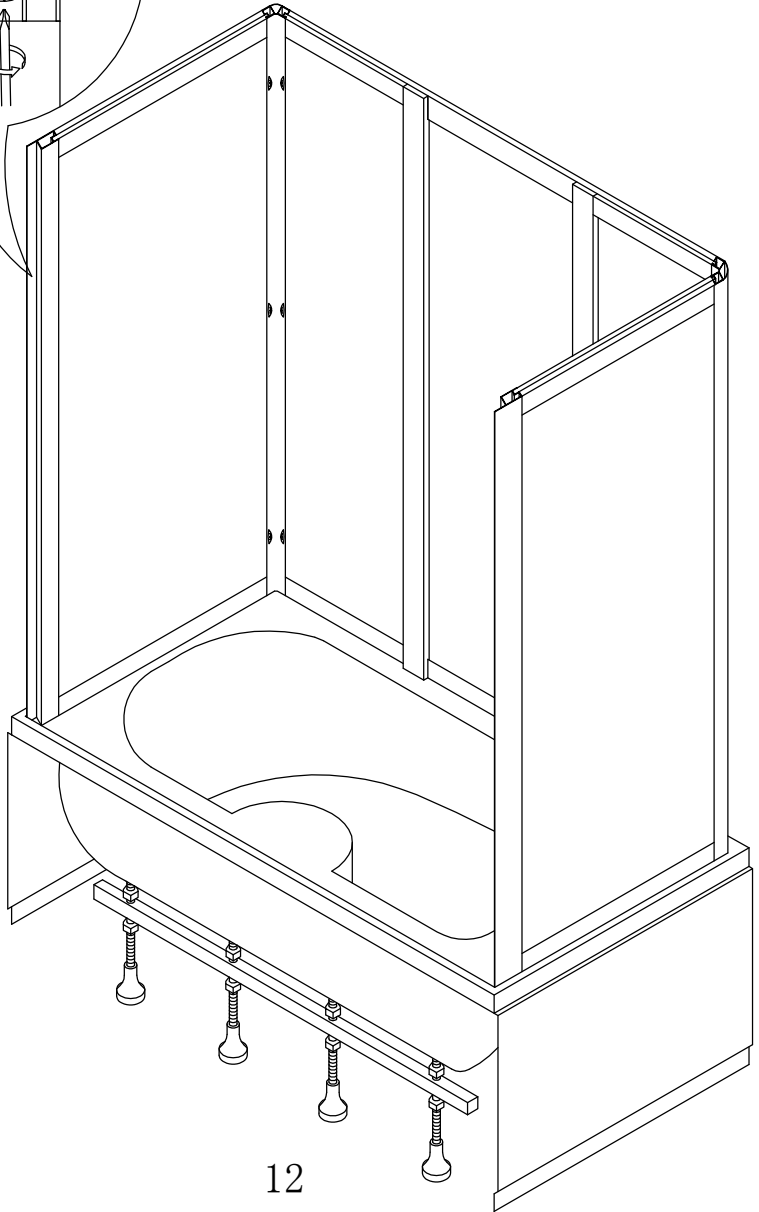
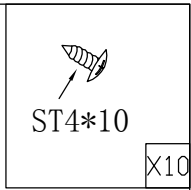
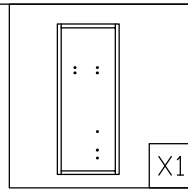
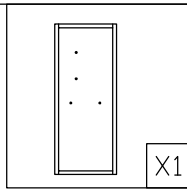
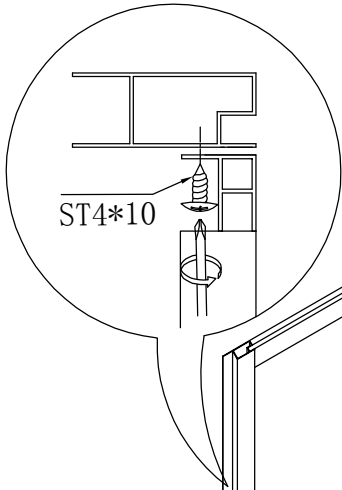

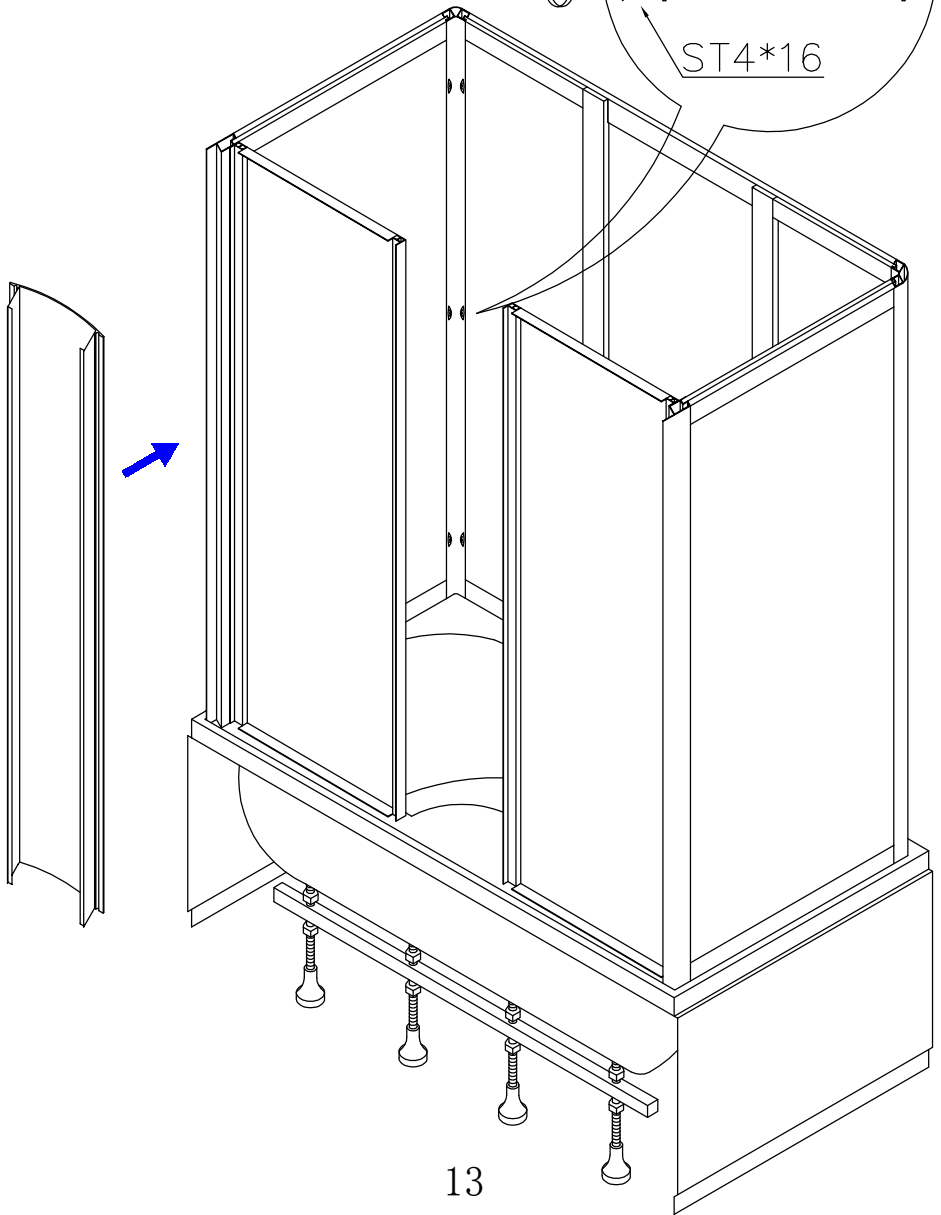
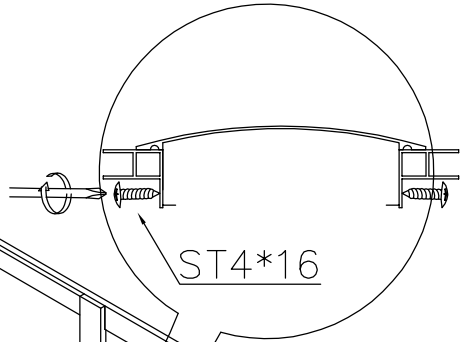
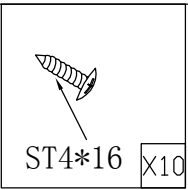
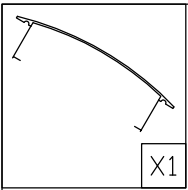



ST4*20

X8

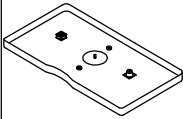

X1

4-ST4*20

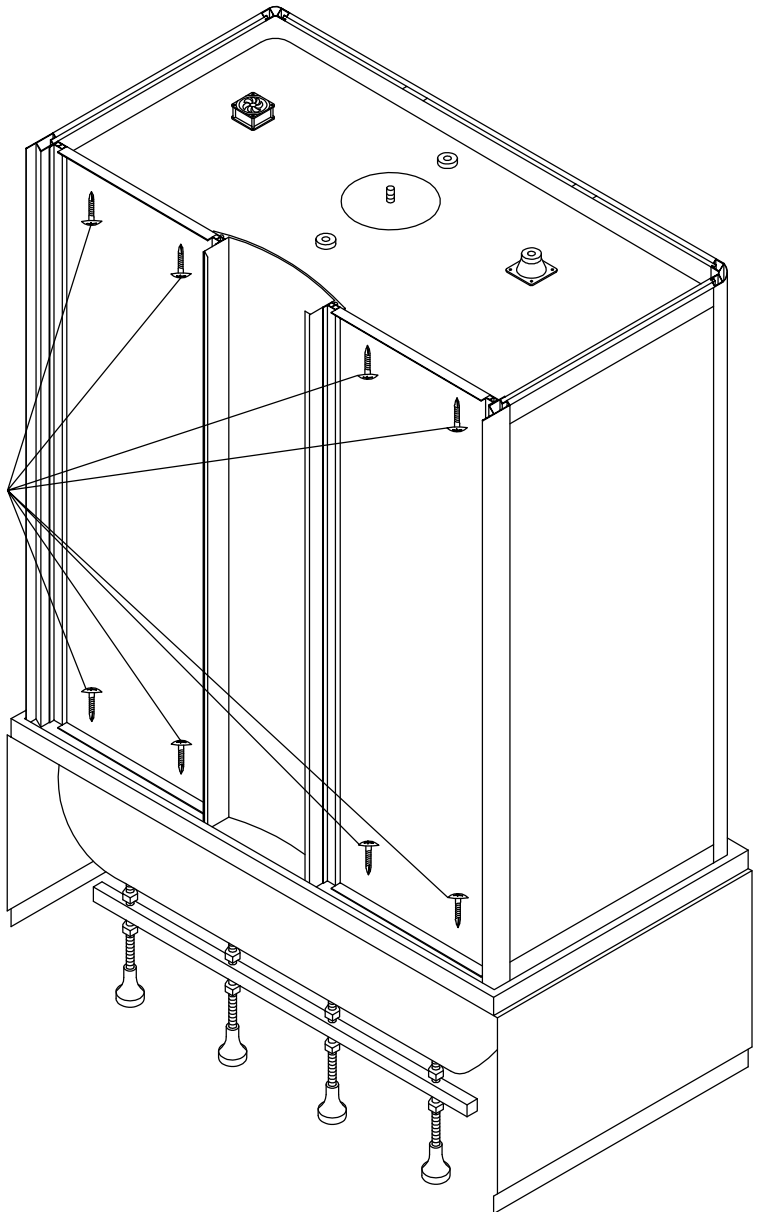

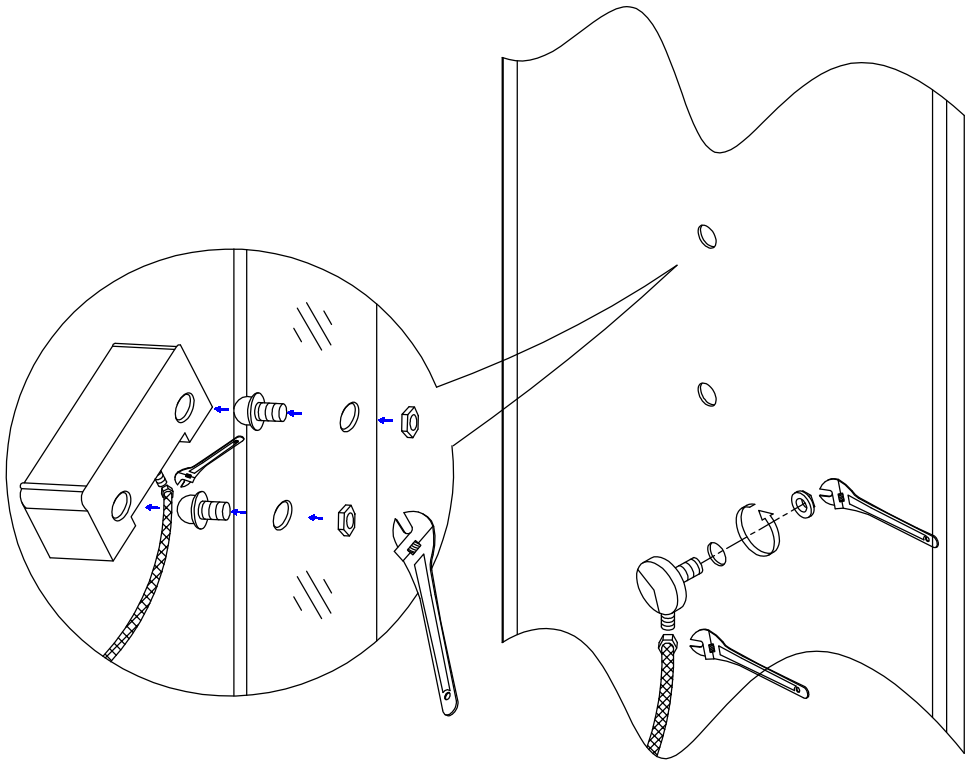
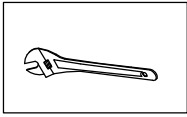
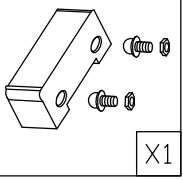

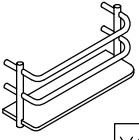

X1

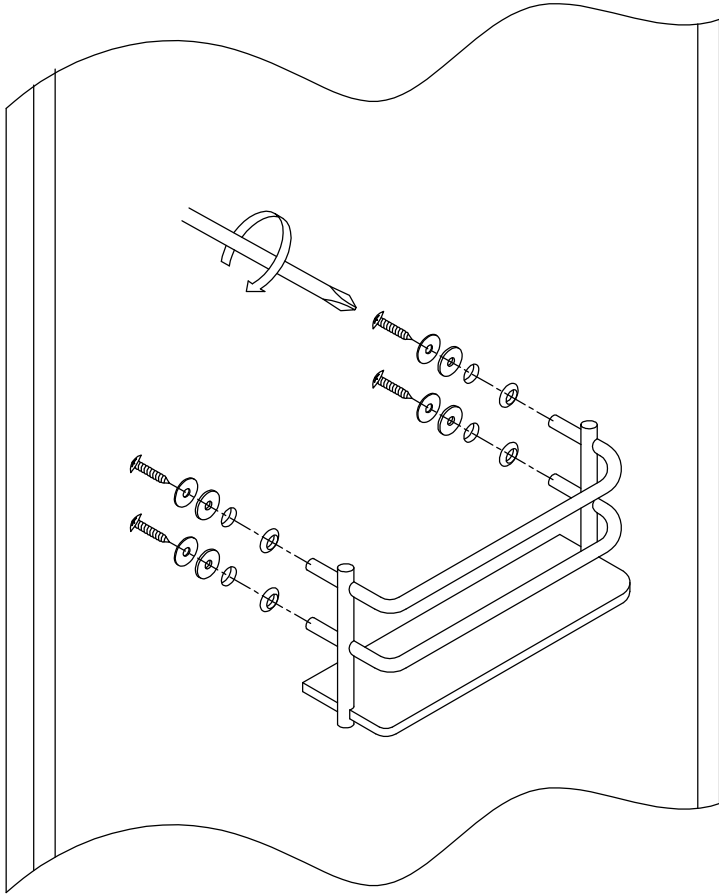
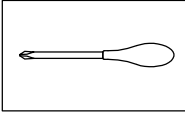



X1

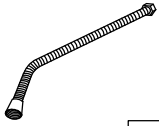

X1

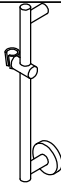

X1

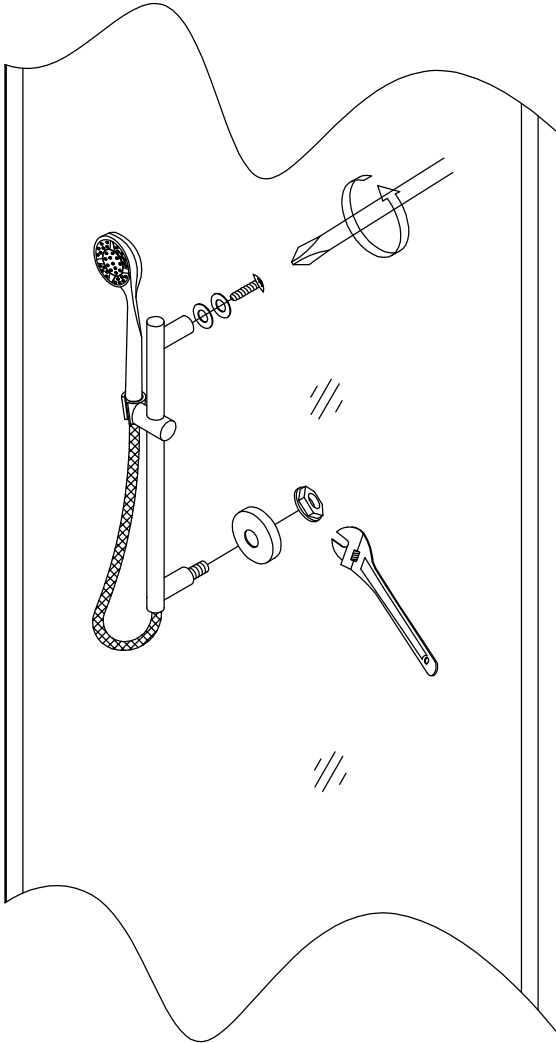
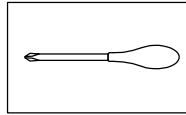

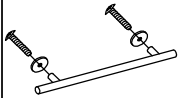

X1

