

9001 EM/EJ

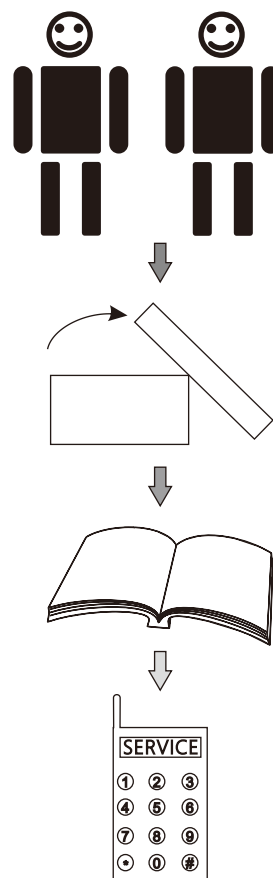

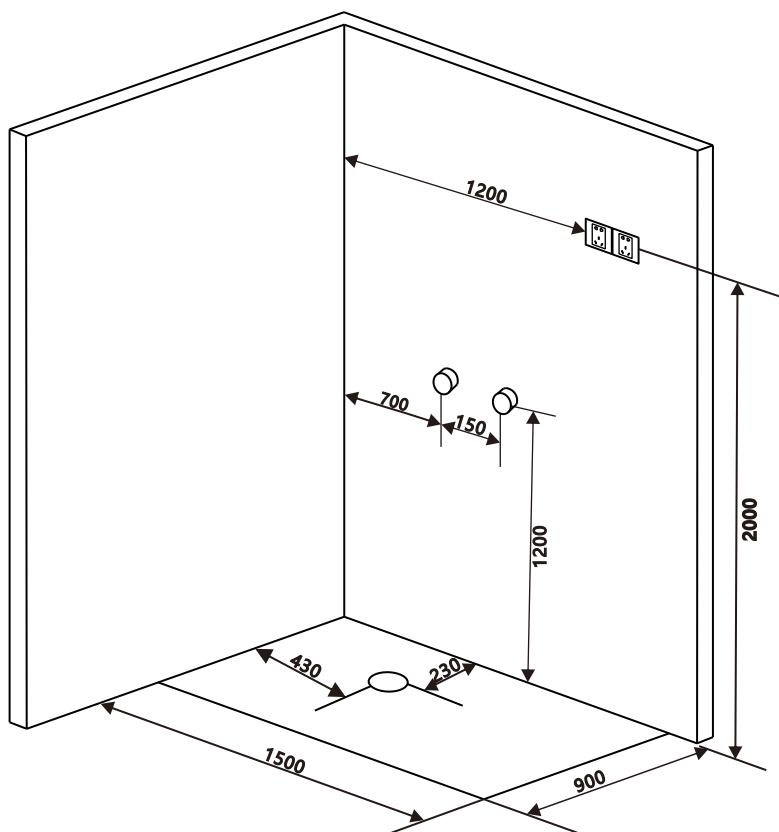

1500*900*2150

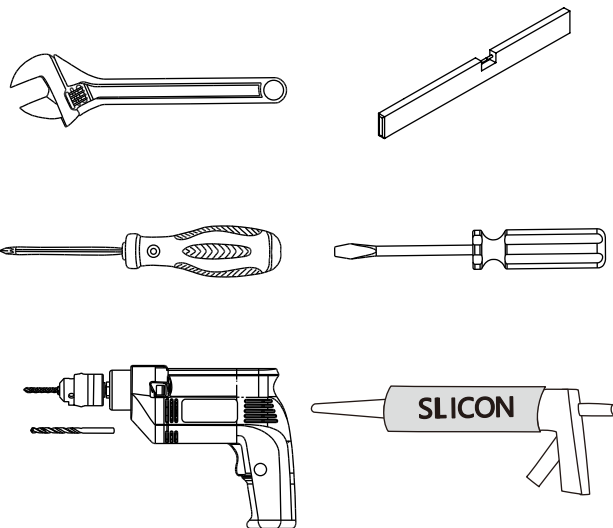
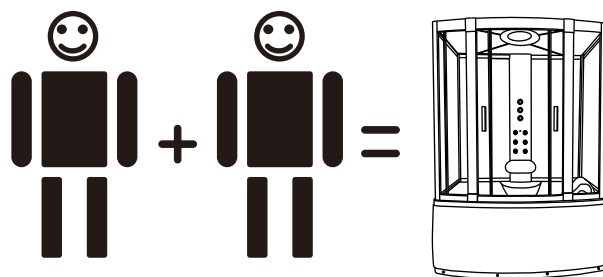
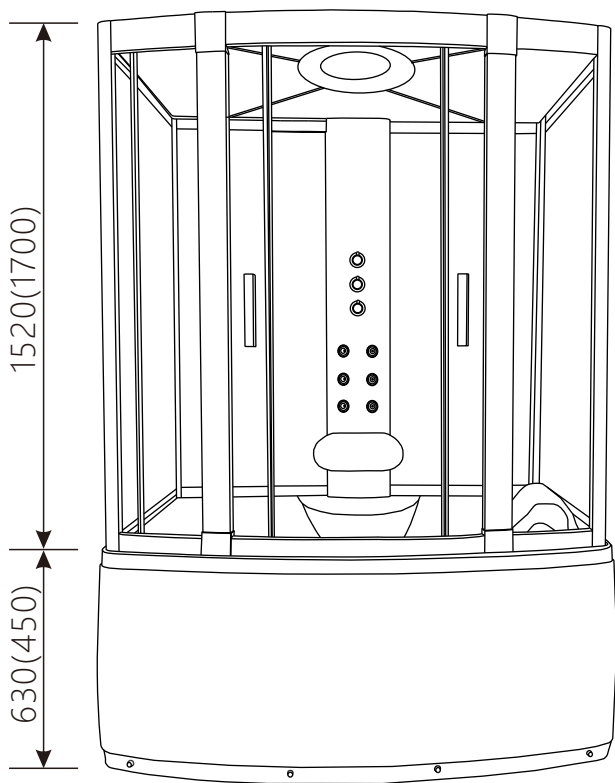

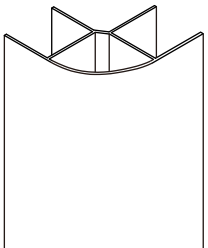
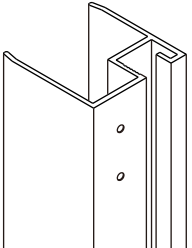
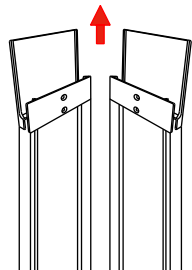
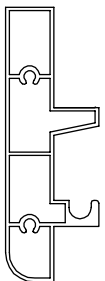
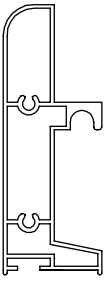
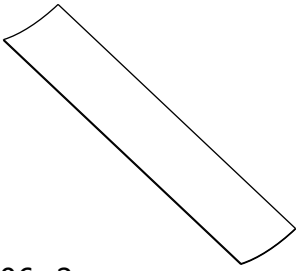
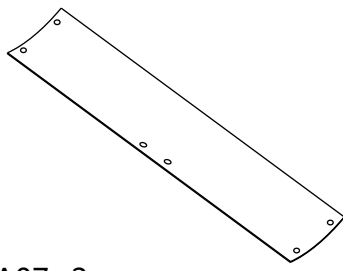
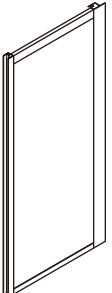
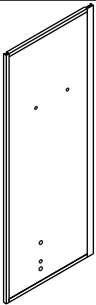
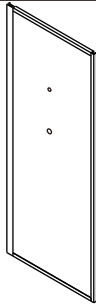
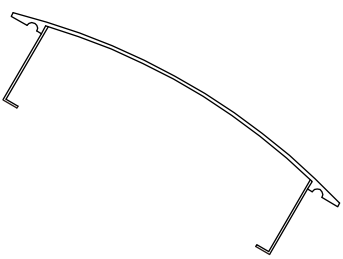
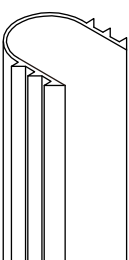
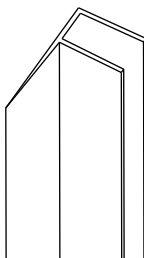
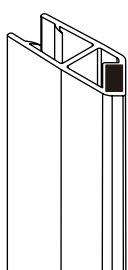
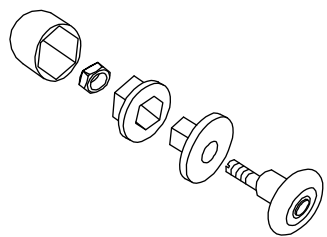
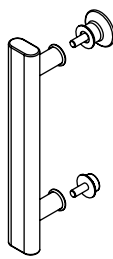
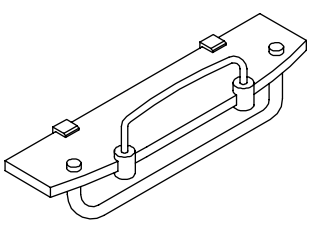
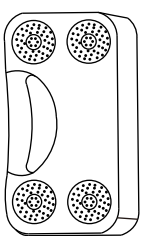
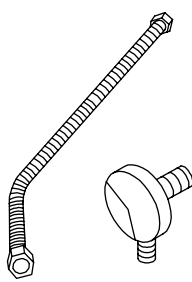
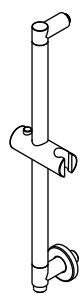
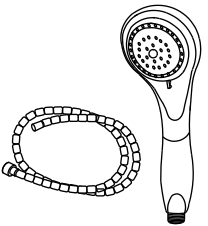
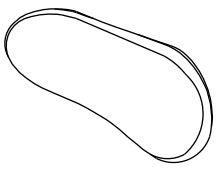
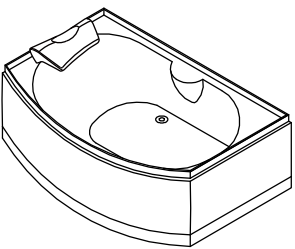
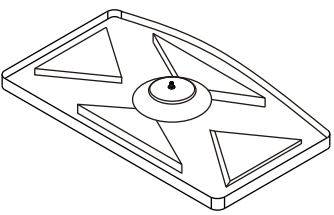

Viktig!

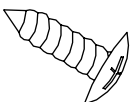
Les nøye gjennom manualen FØR montering starter. Sjekk også at antall deler samsvarer med deleoversikten og kontakt kundeservice om det oppdages mangler eller feil på mottatte deler.

 <p>A01=2</p>	 <p>A02=2</p>	 <p>A03=2</p>	 <p>A04=1</p>
 <p>A05=1</p>	 <p>A06=2</p>	 <p>A07=2</p>	 <p>A08=2</p>
 <p>A09=1</p>	 <p>A10=1</p>	 <p>A11=1</p>	 <p>A12=4</p>
 <p>A13=2</p>	 <p>A14=2</p>	 <p>A15=8</p>	 <p>A16=2</p>
 <p>B01=1</p>	 <p>B02=1</p>	 <p>B03=1</p>	 <p>B04=1</p>
 <p>B05=1</p>	 <p>B06=1</p>	 <p>C01=1</p>	 <p>D01=1</p>
 <p>ST4*10=12</p>	 <p>ST4*16=22</p>	 <p>ST4*20=8</p>	

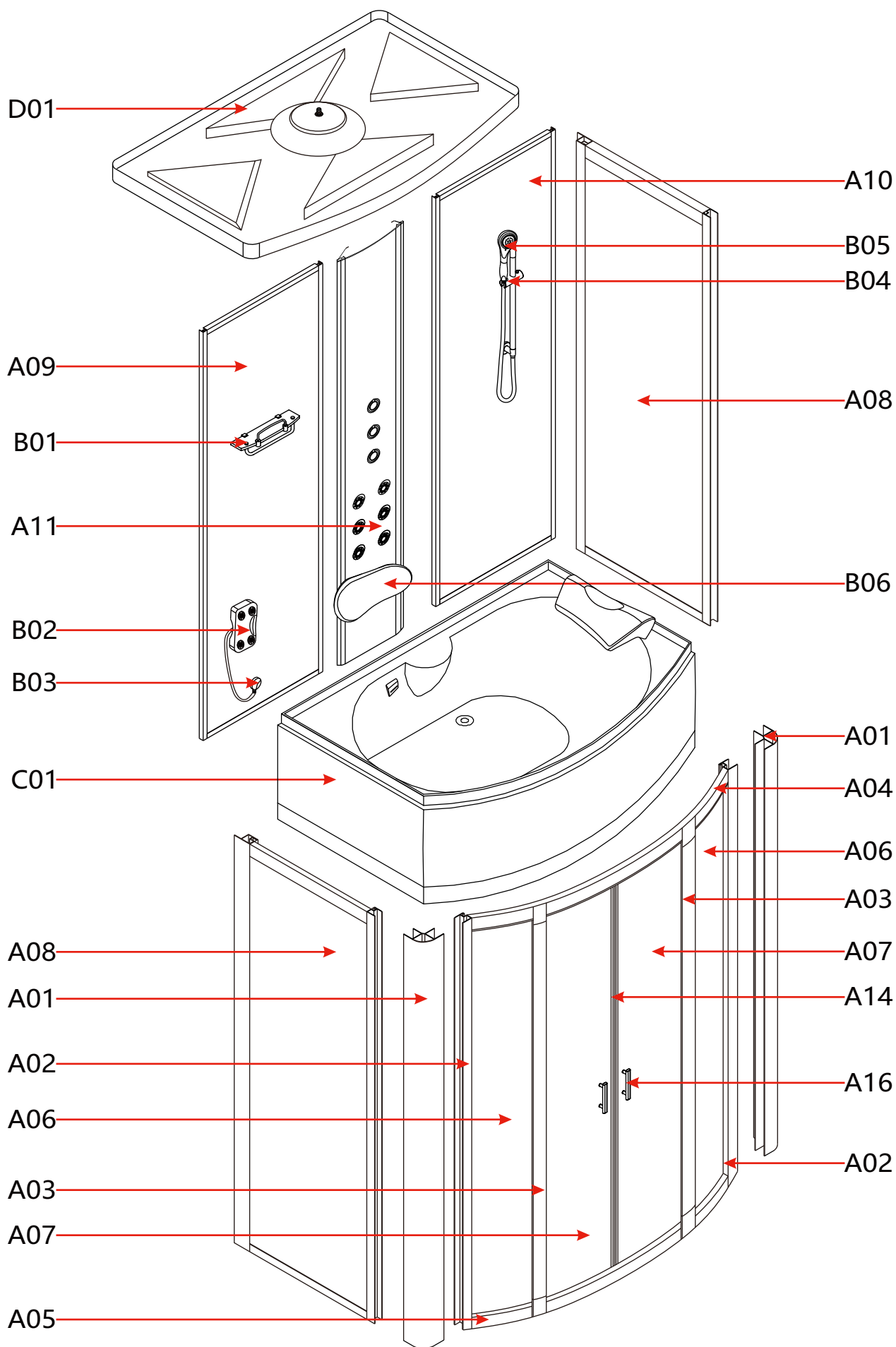

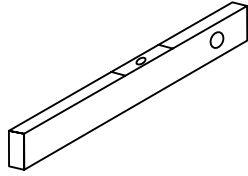
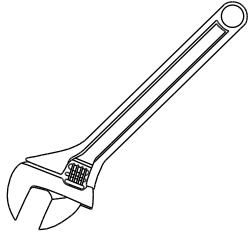
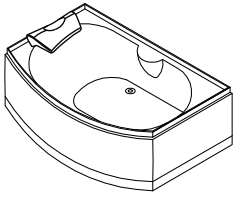

C01=1

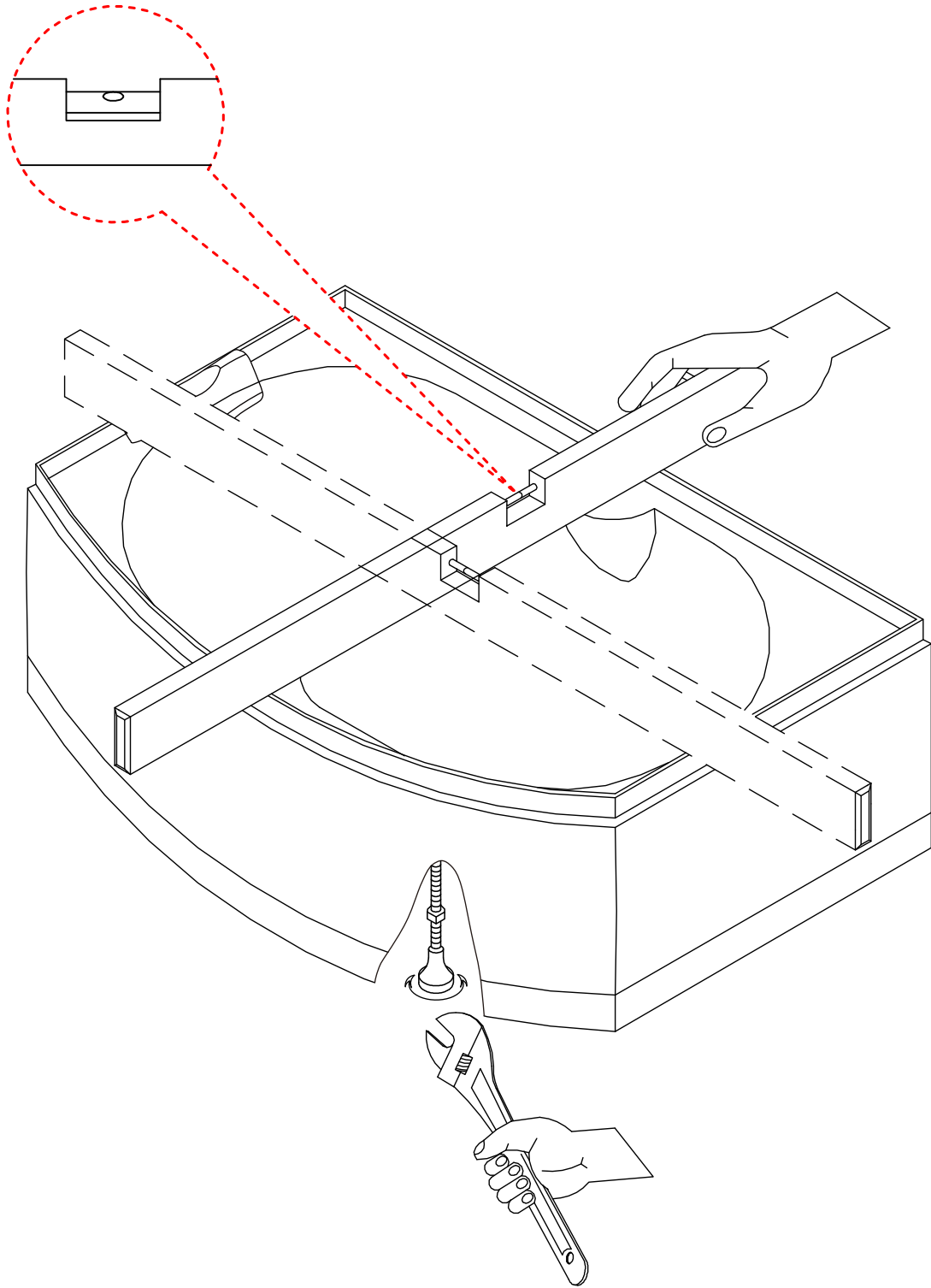

A02=2

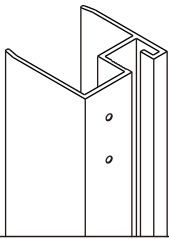

A03=1

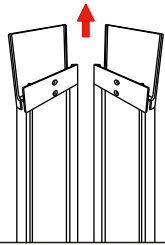

A04=1



A05=1

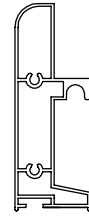

ST4*16=8

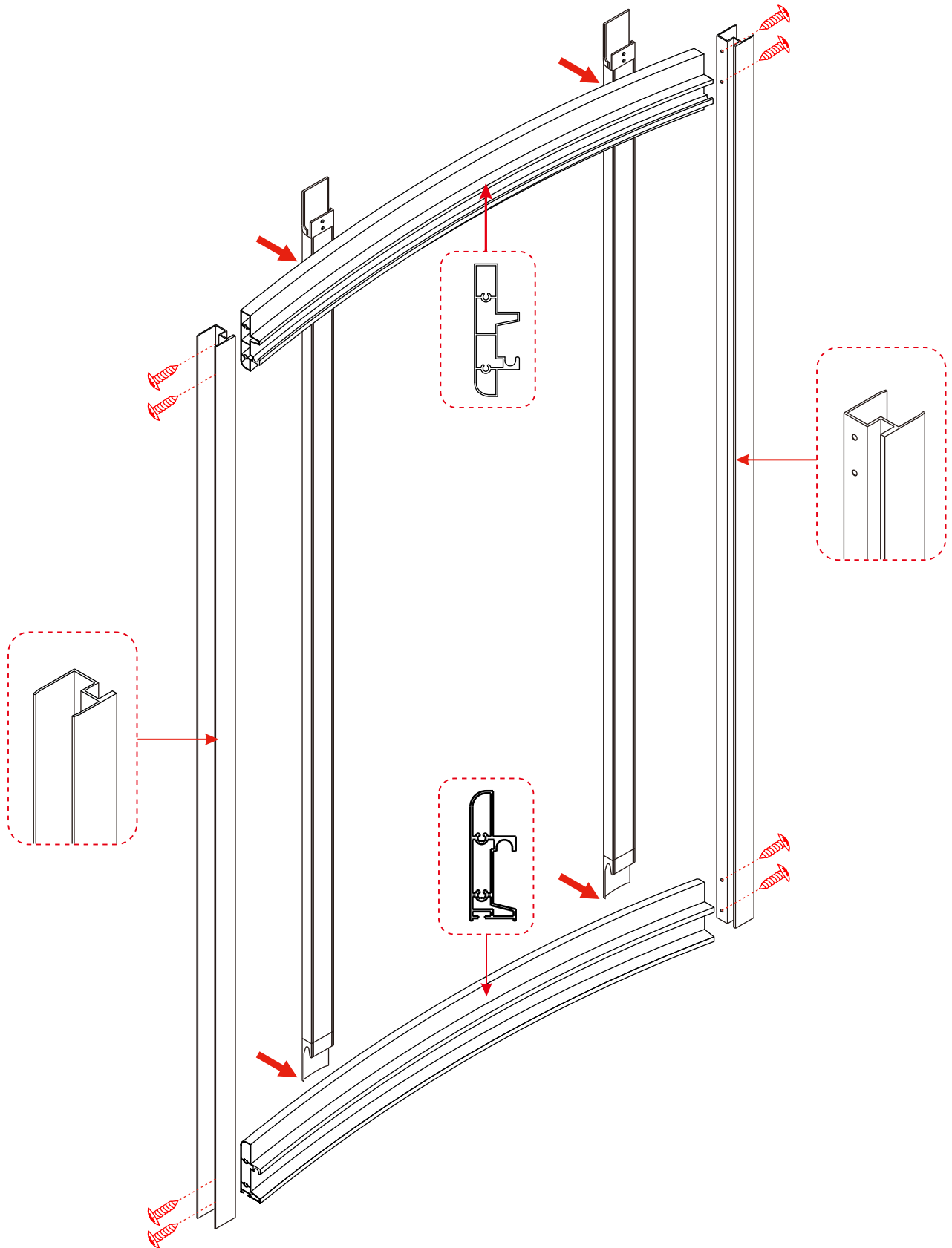
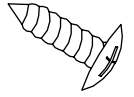

A06=2

A12=4

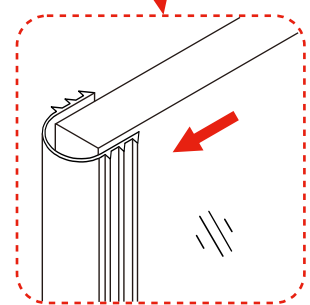
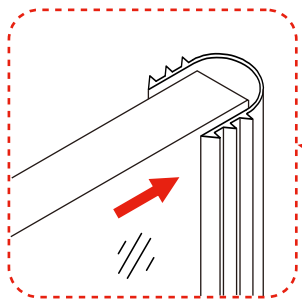
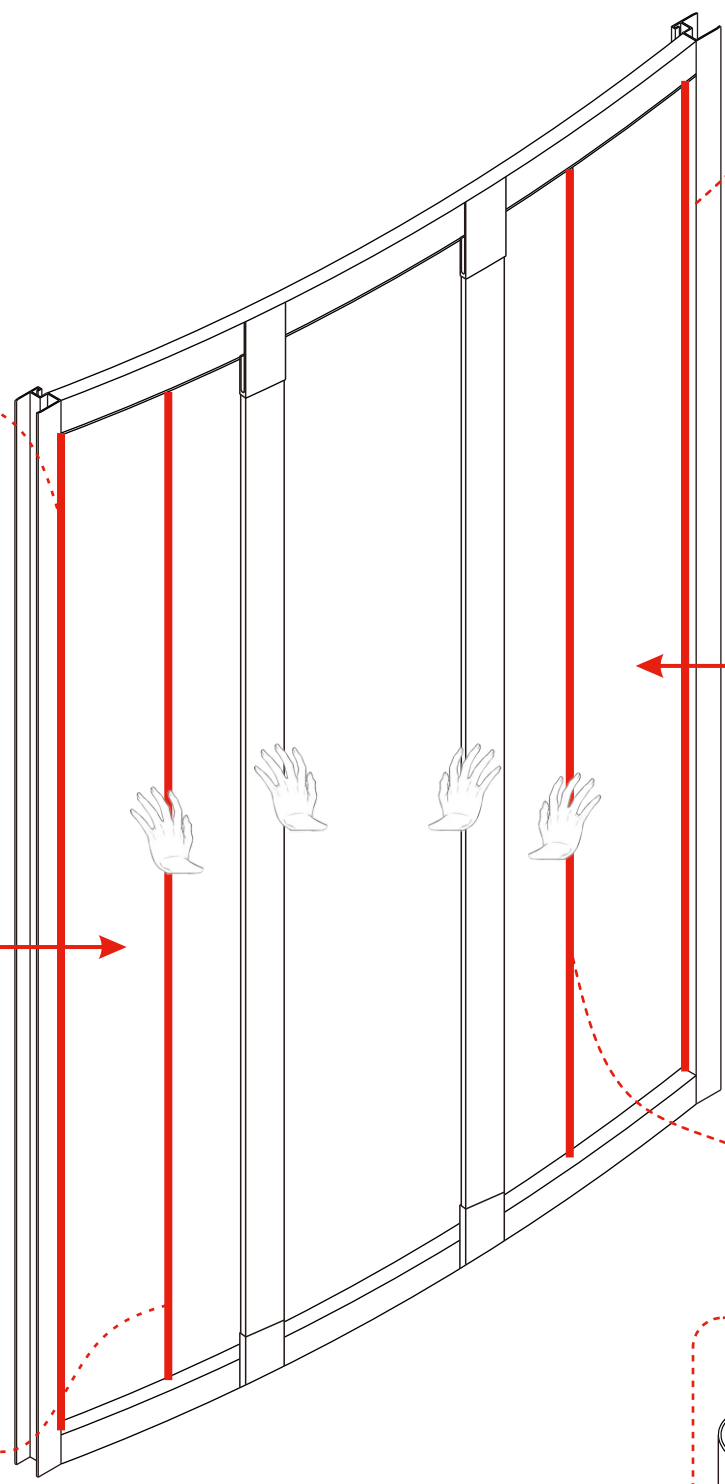
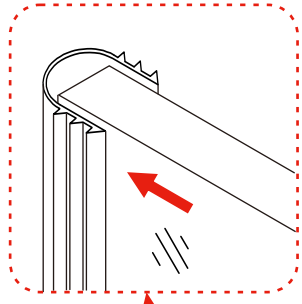
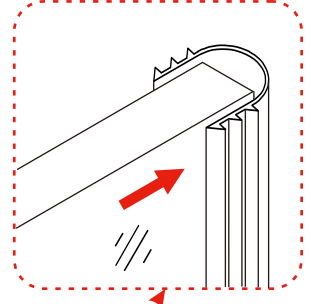
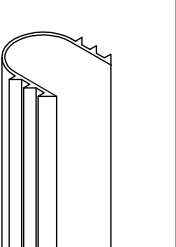
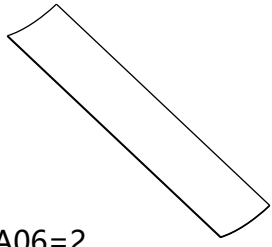

A06=2

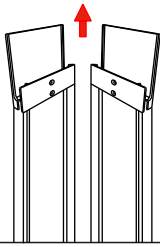

ST4*16=4

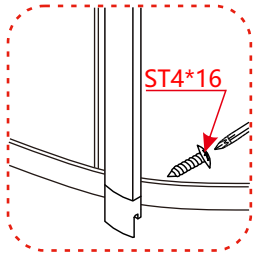
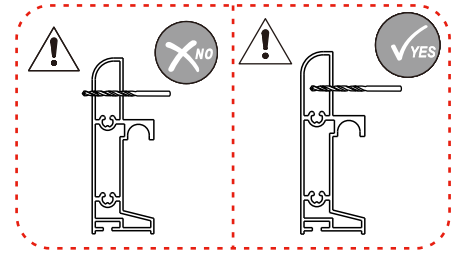
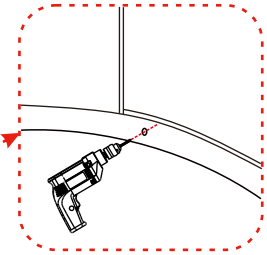
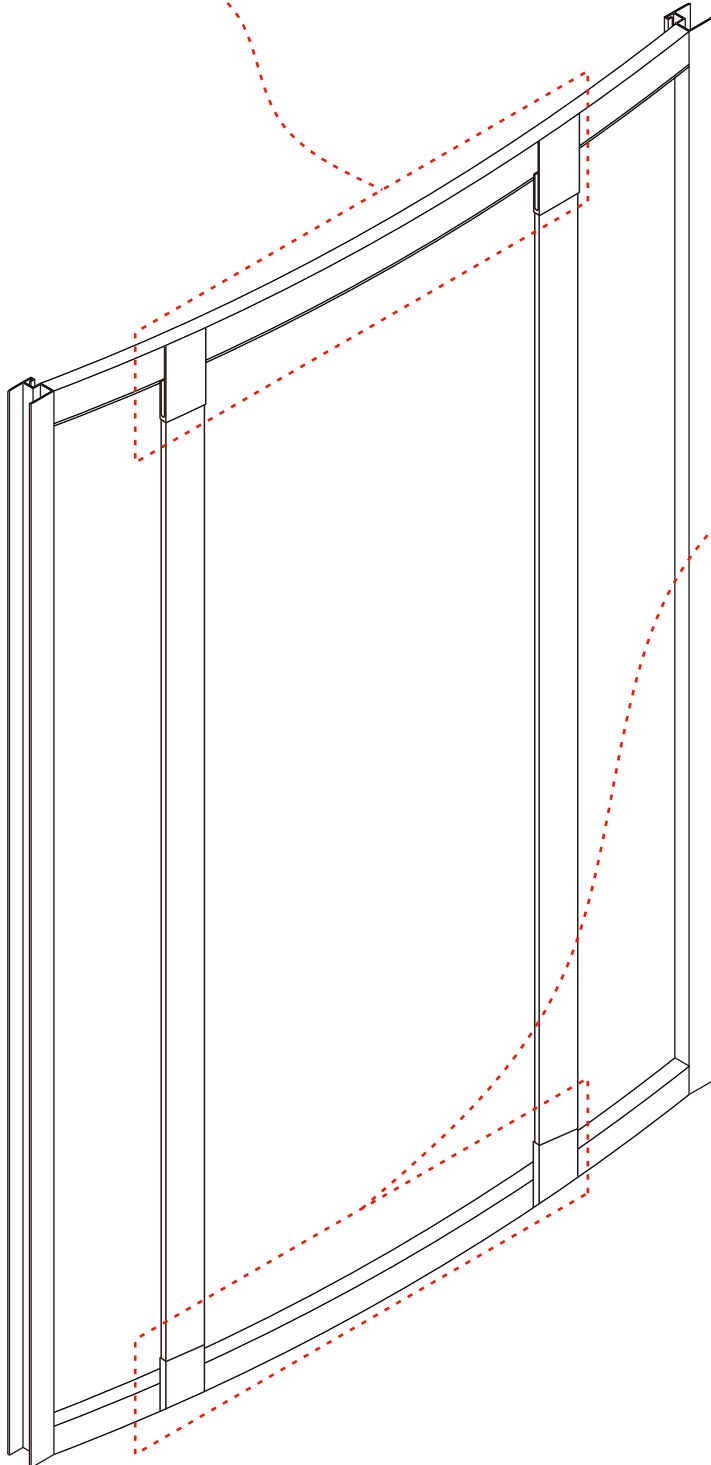
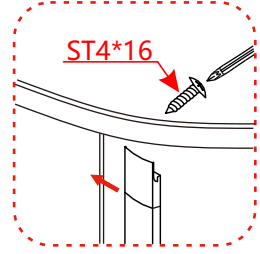
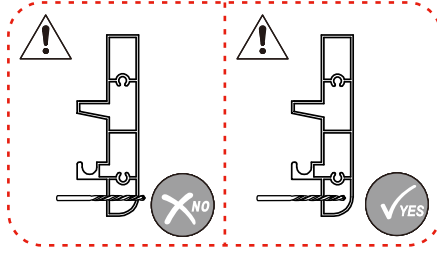
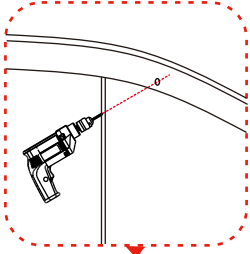
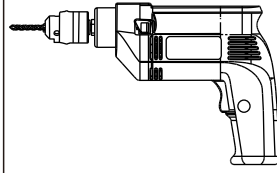
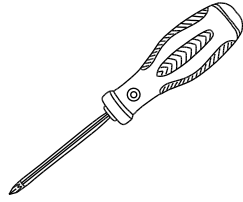

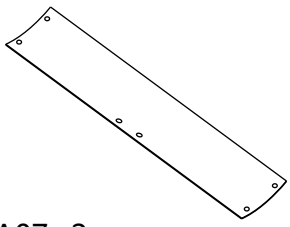

A07=2

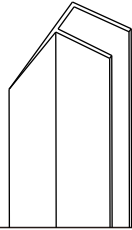

A13=2

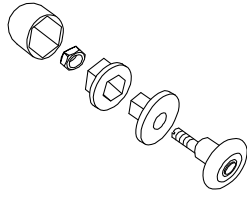

A15=8

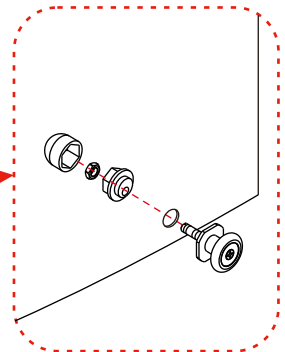
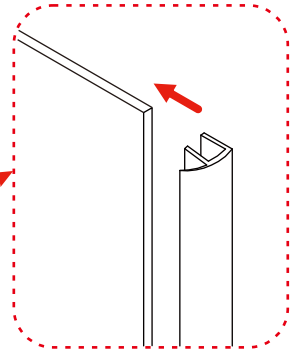
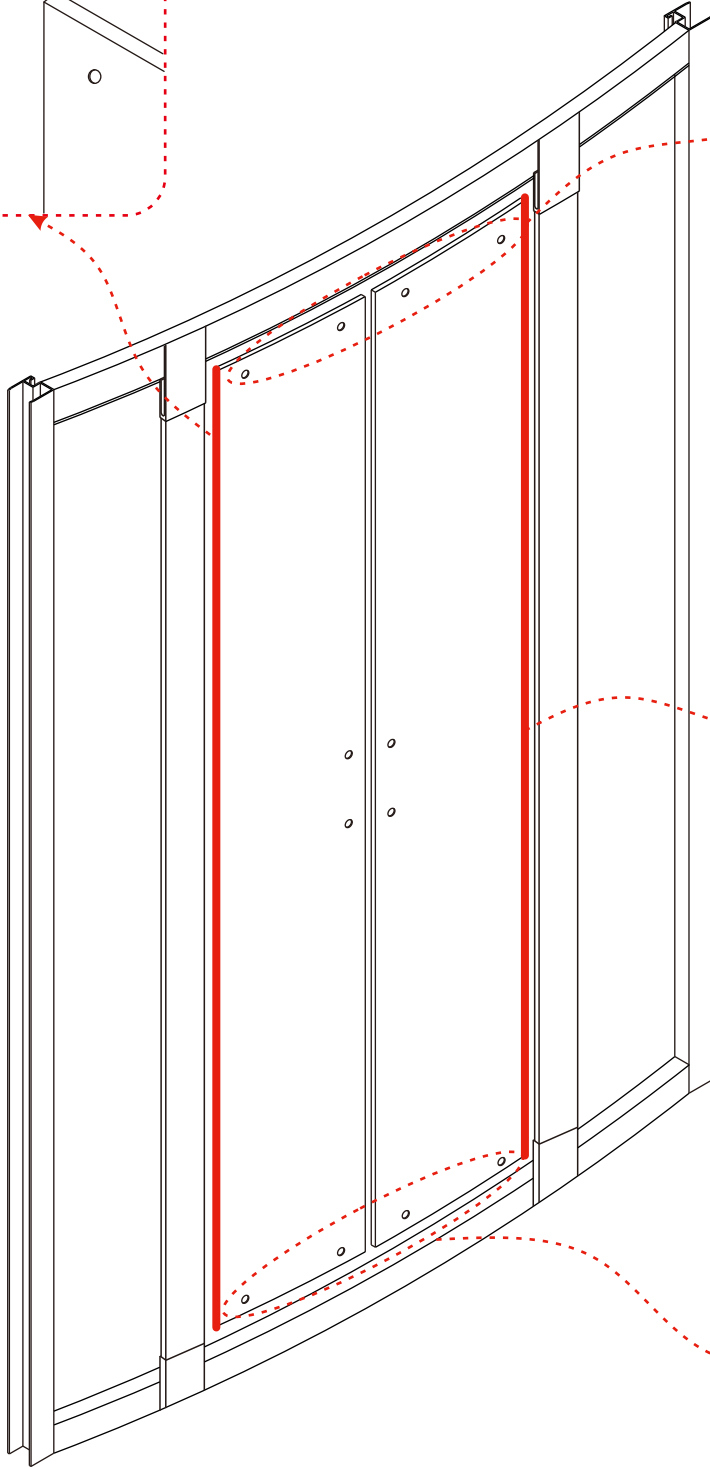
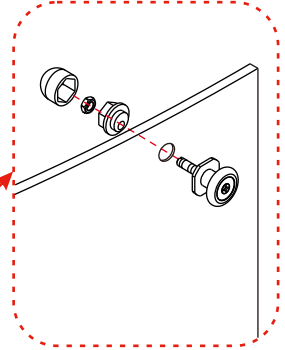
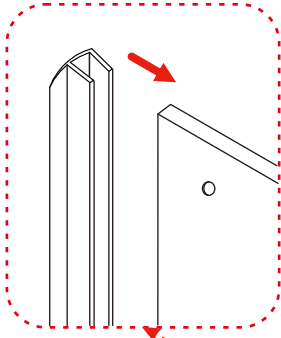

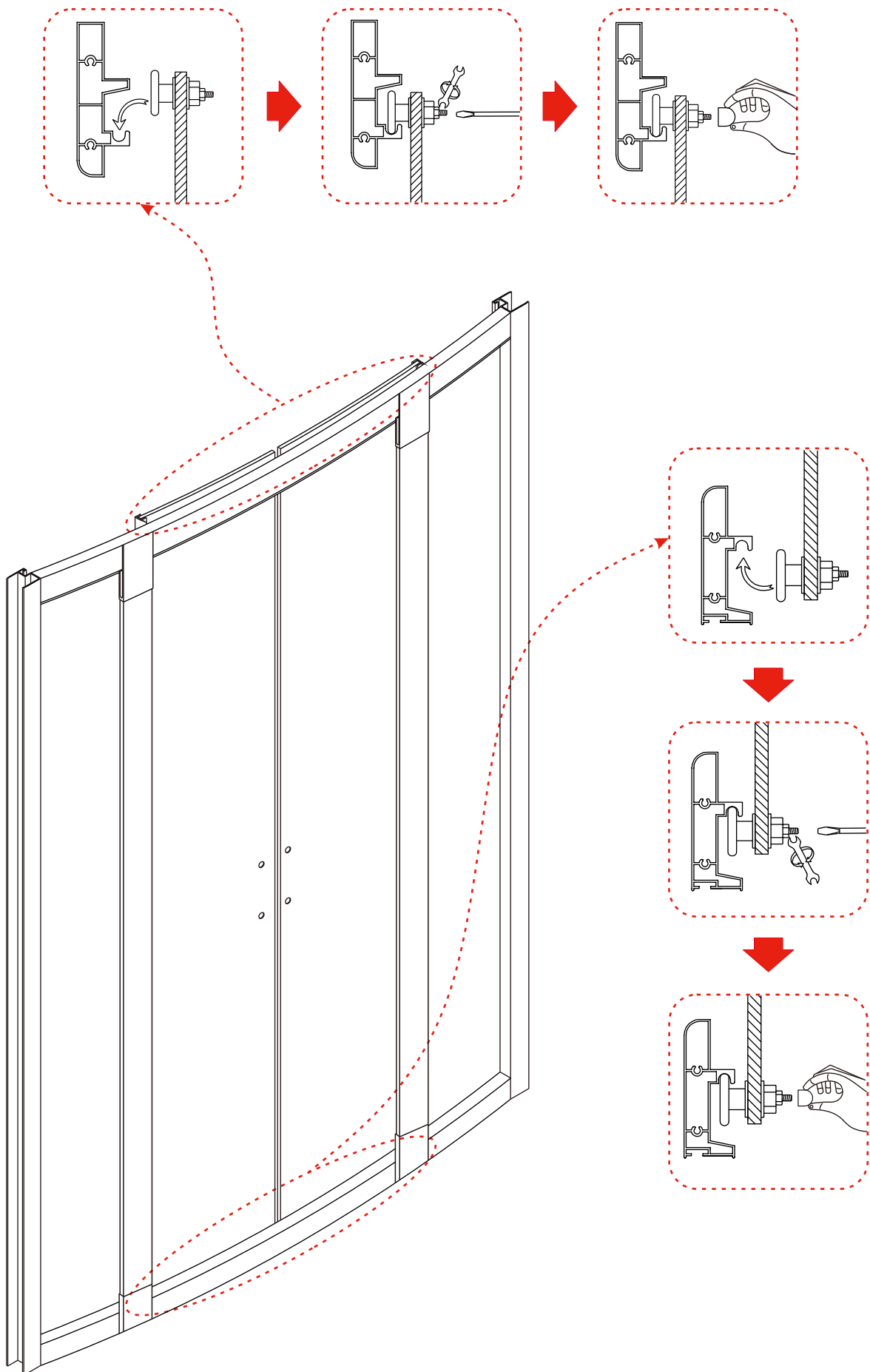

A14=2

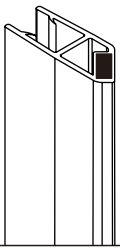

A16=2

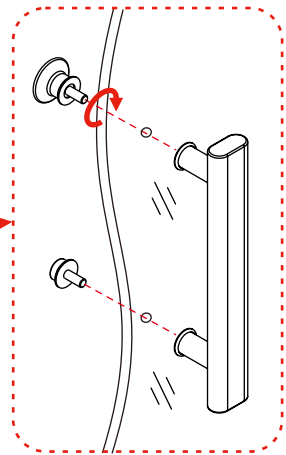
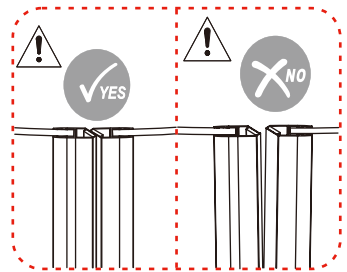
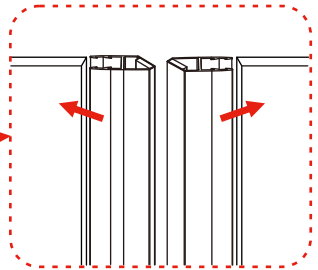
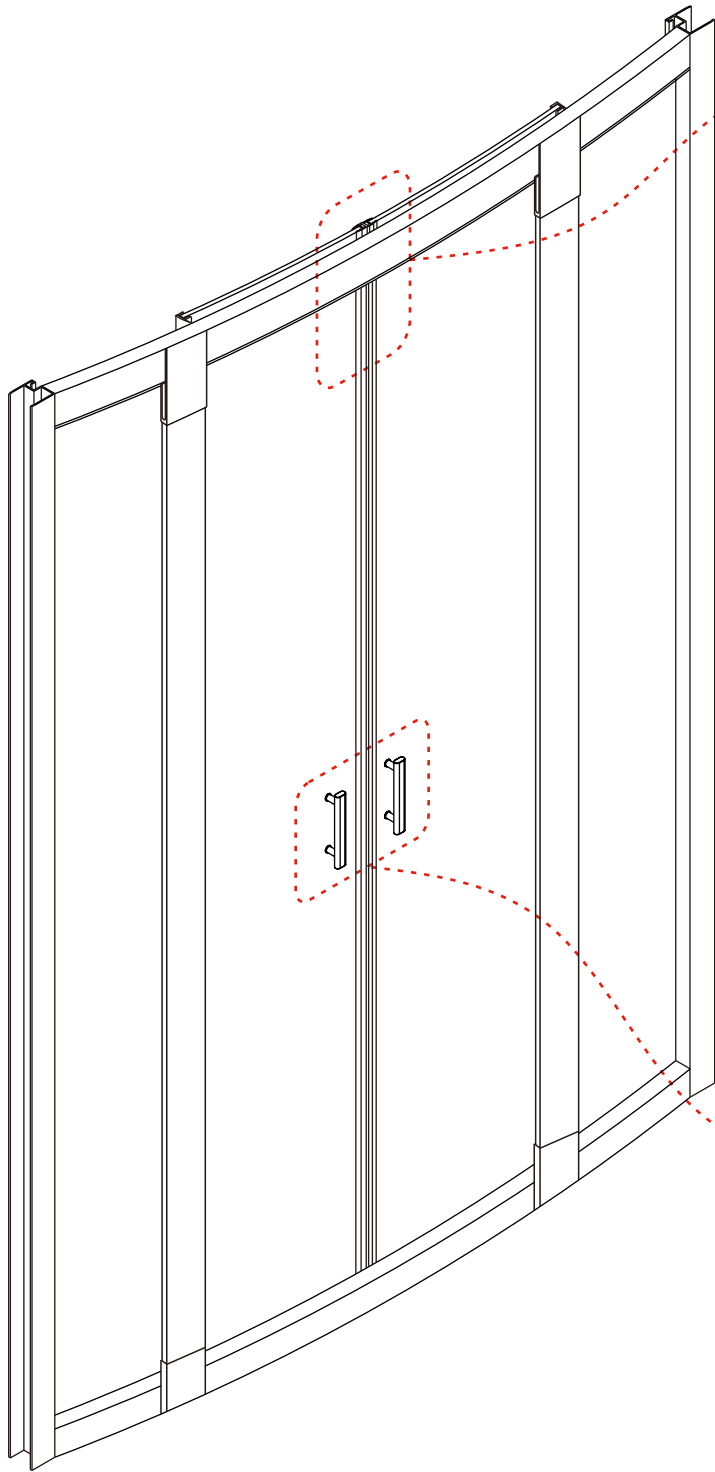
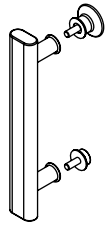

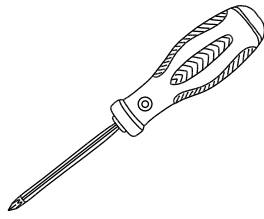
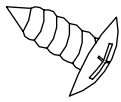

A01=2

ST4*10=6

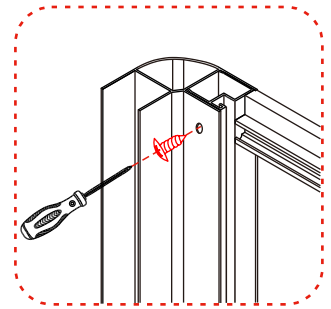
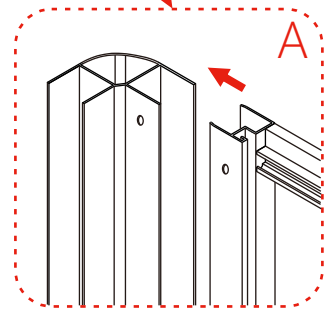
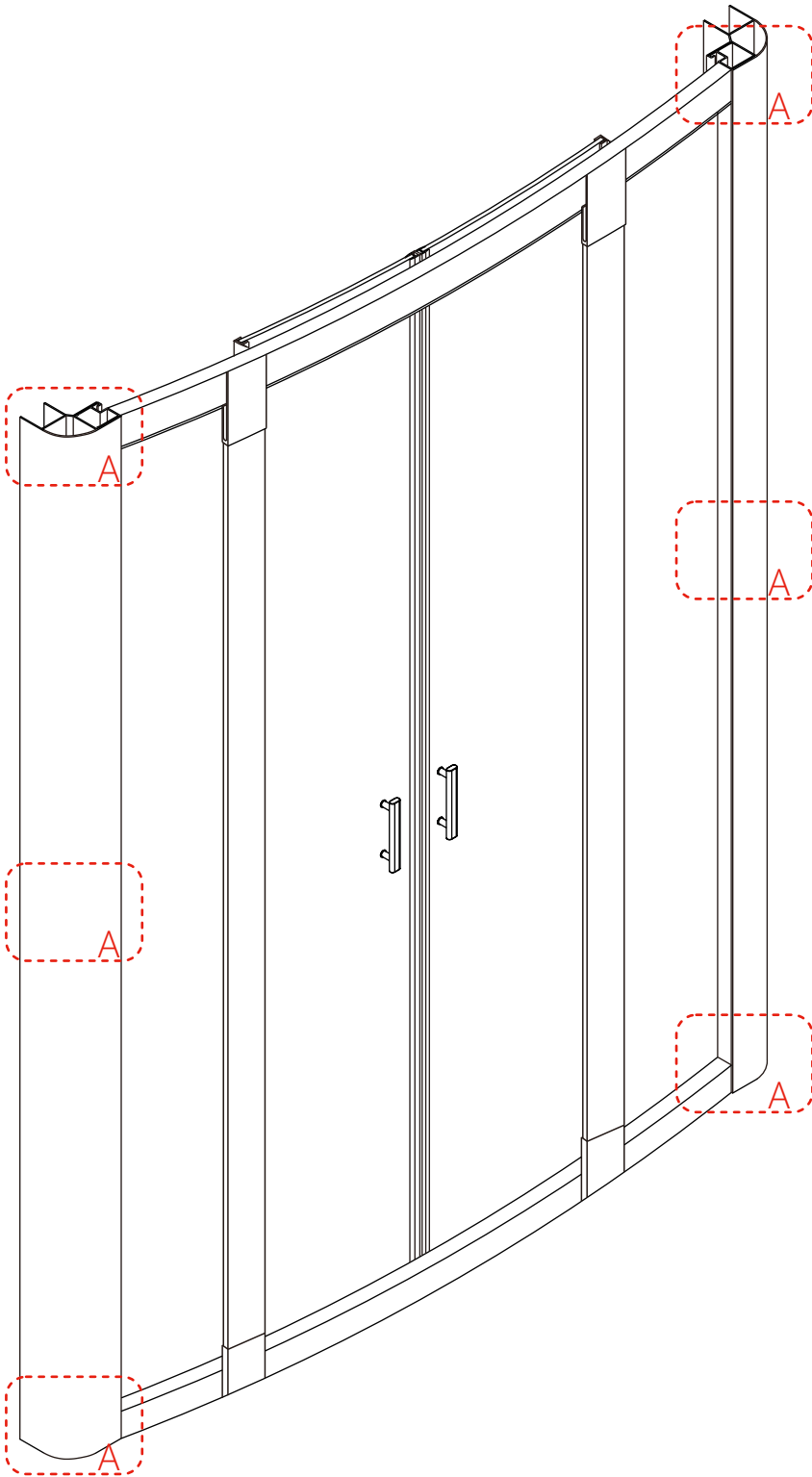

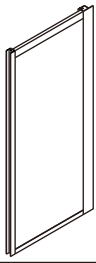

A08=2

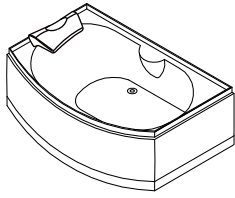

C01=1

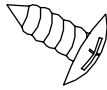

ST4*10=6

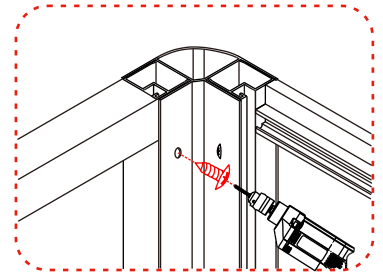
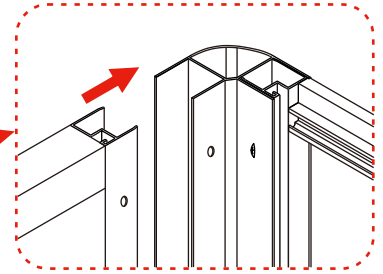
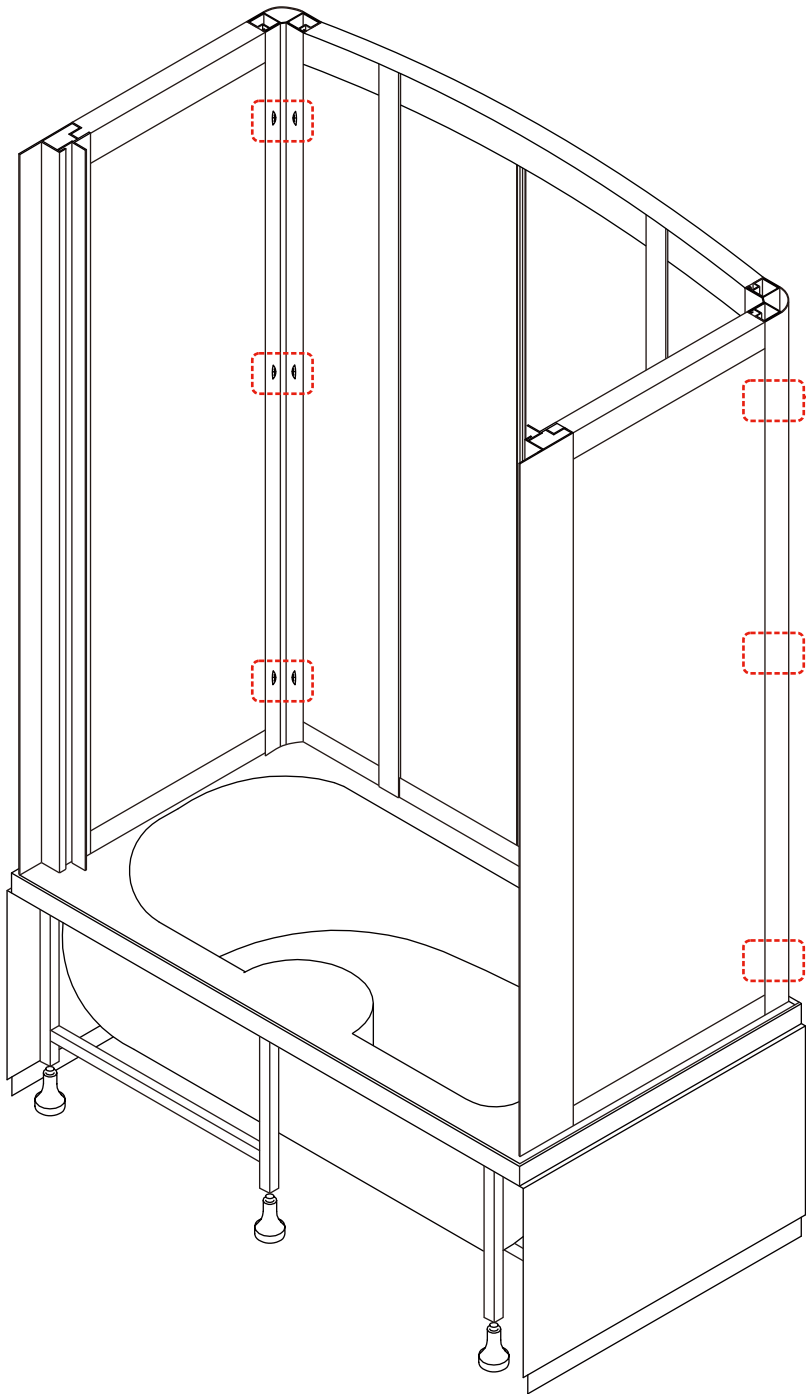
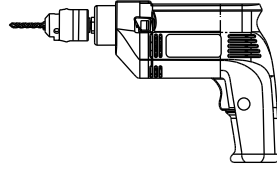

A09=1



A10=1

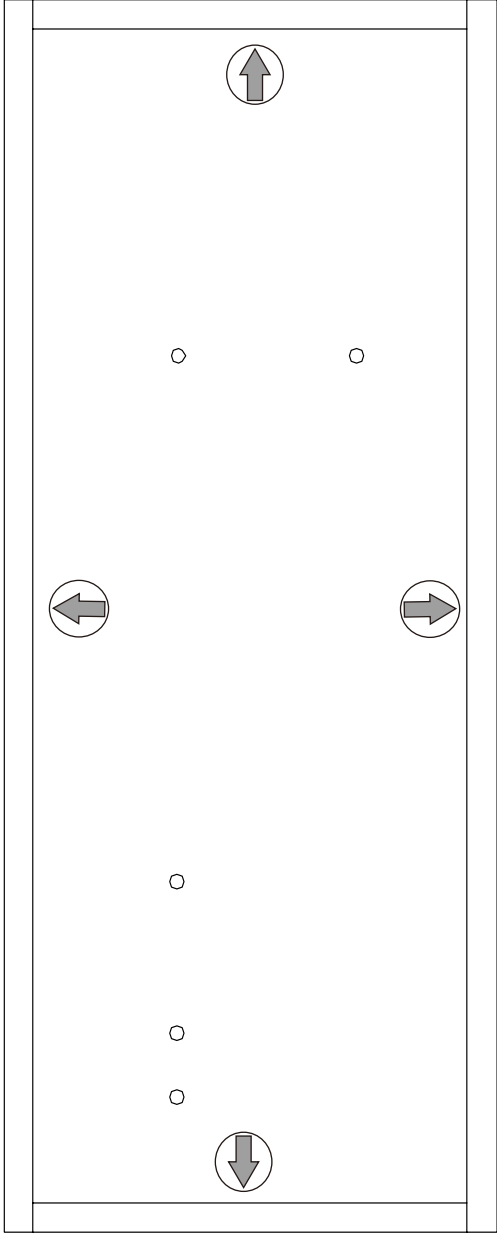

A09

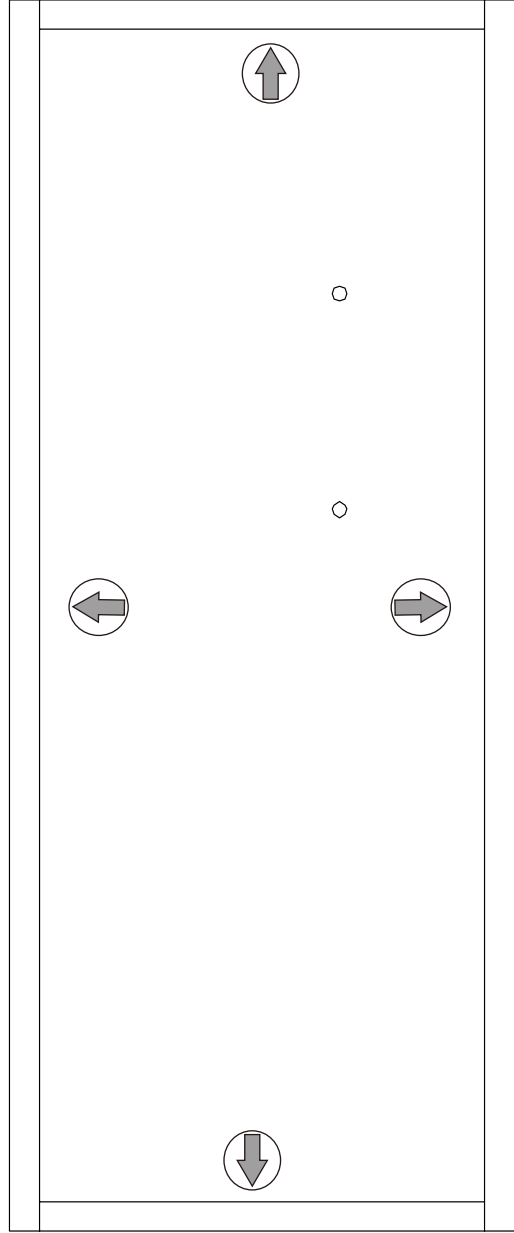

A10

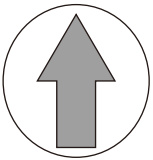

up

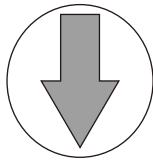

down

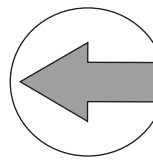

left

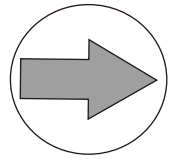

right



A09=1

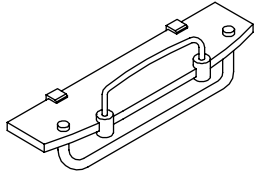

B01=1

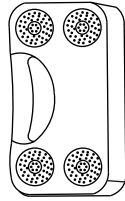

B02=1

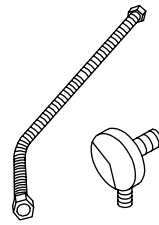

B03=1

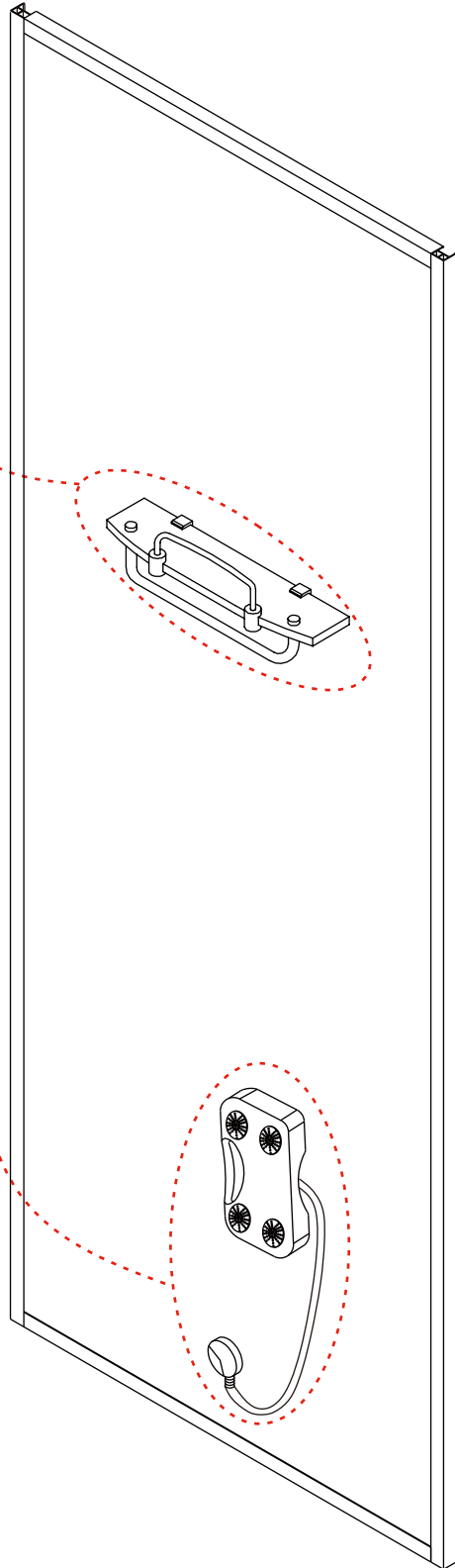
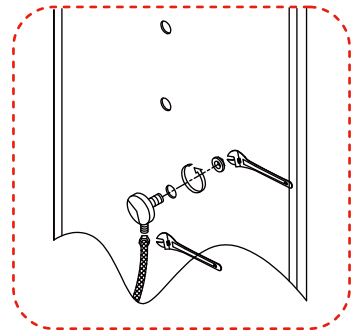
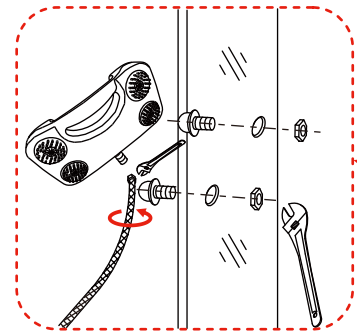
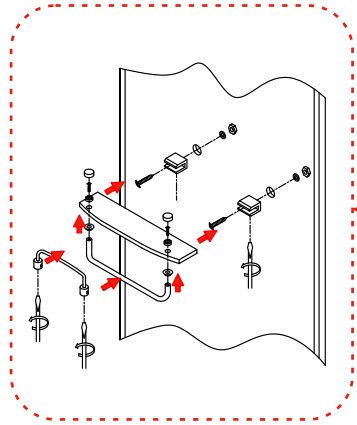

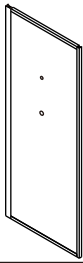

A10=1

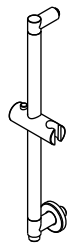

B04=1

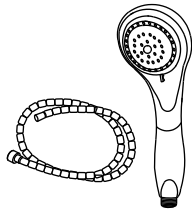

B05=1

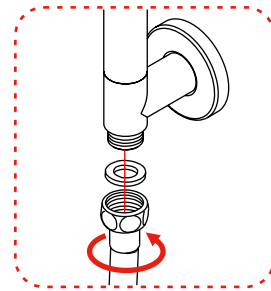
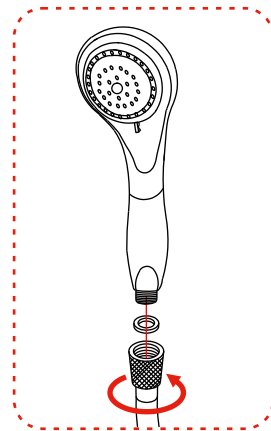
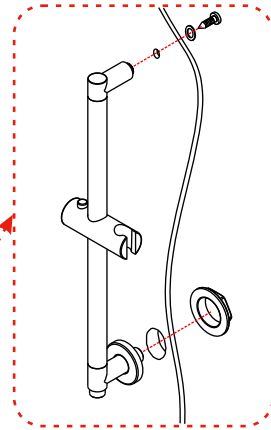
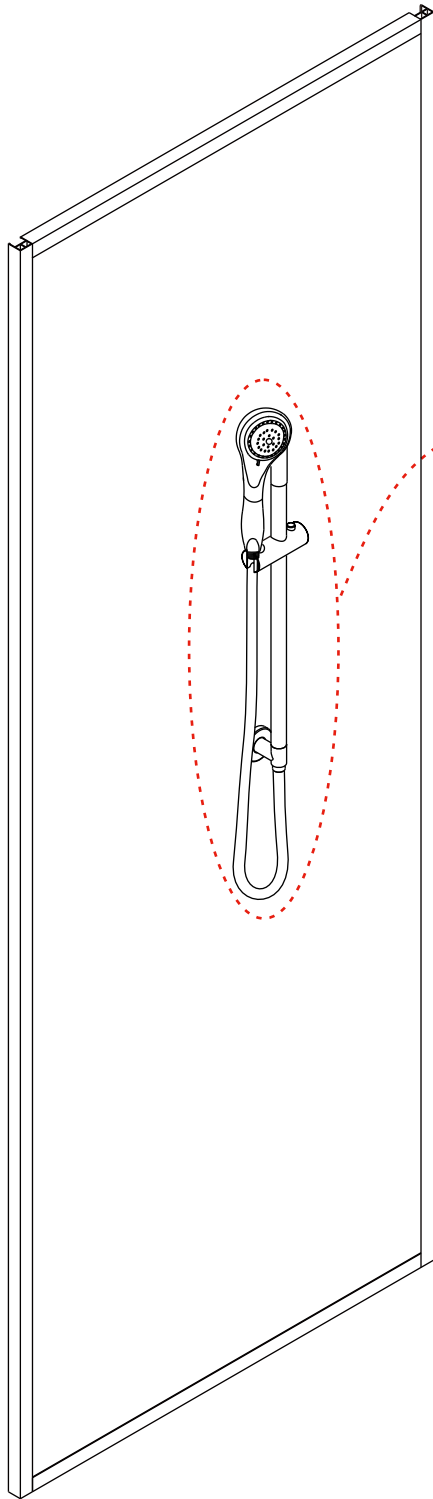

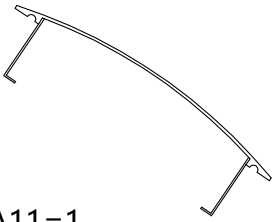

A11=1

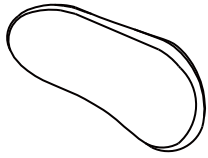

B06=1

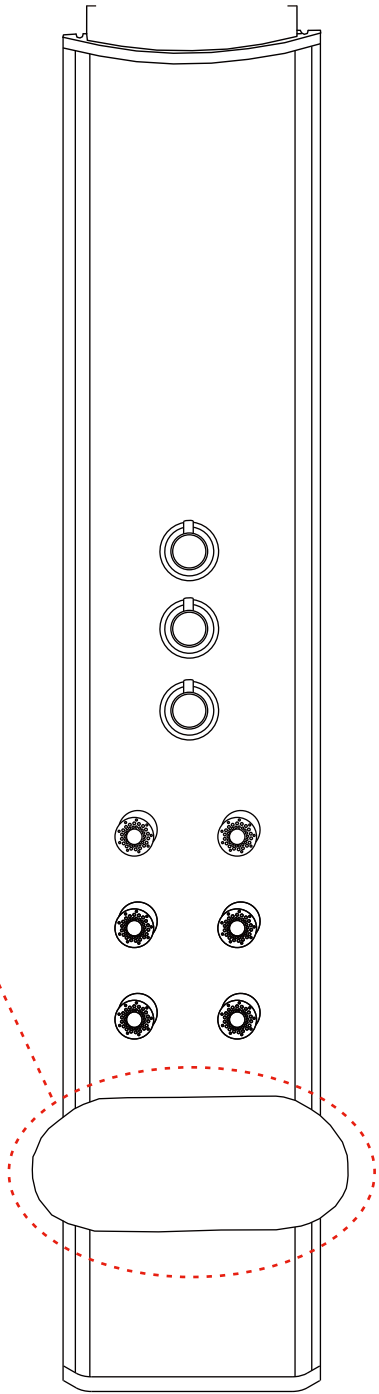
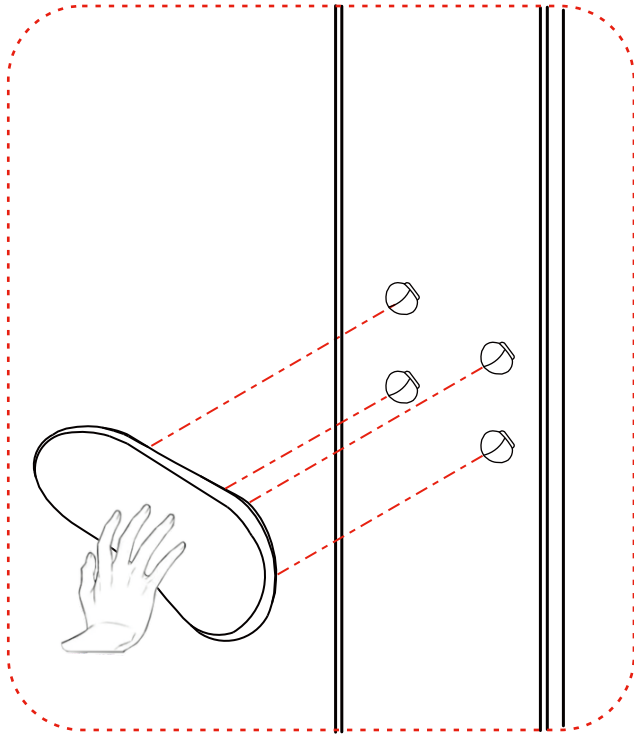

A09=1

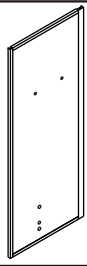

A10=1

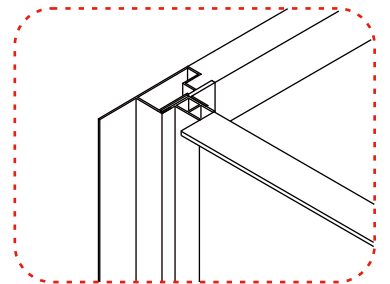
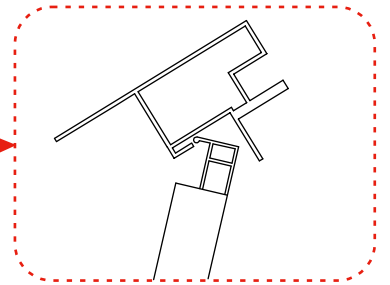
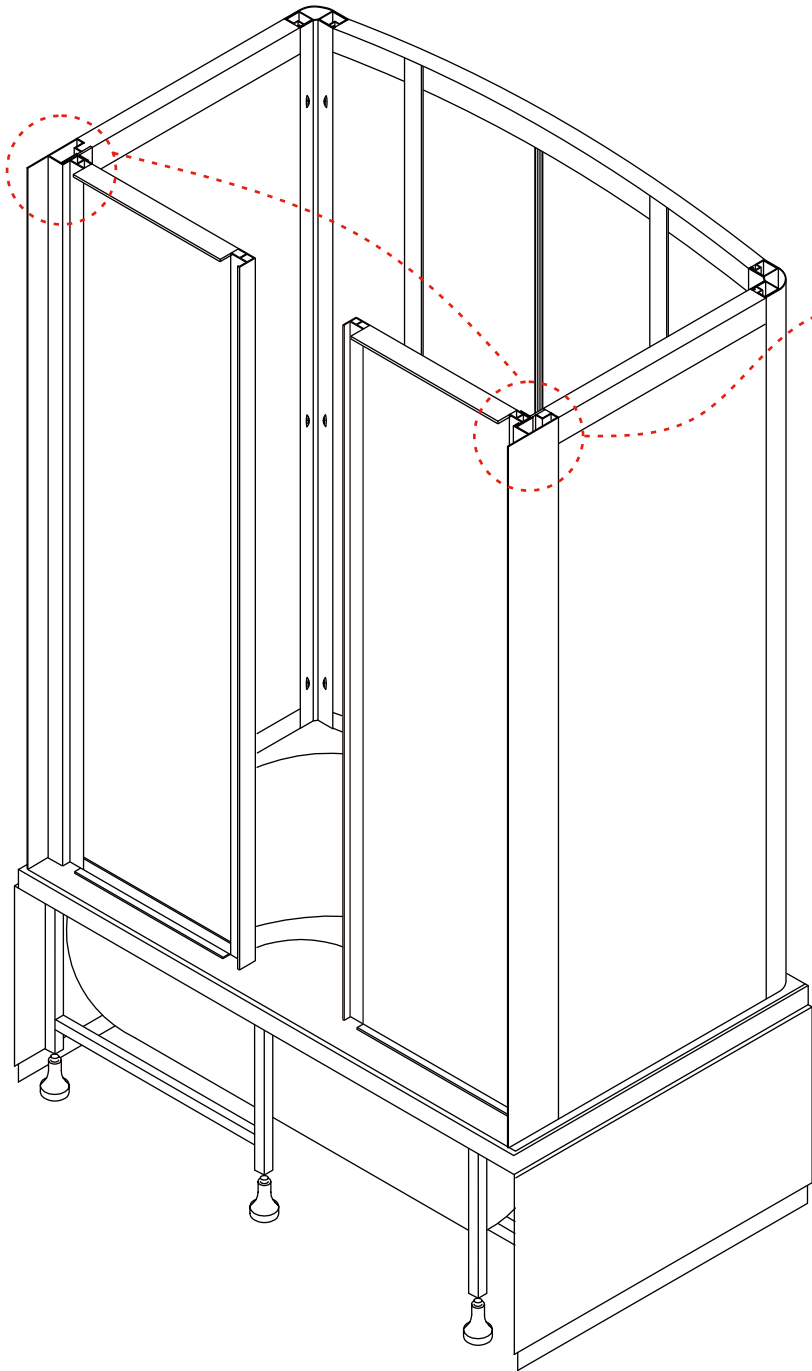
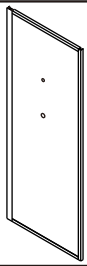

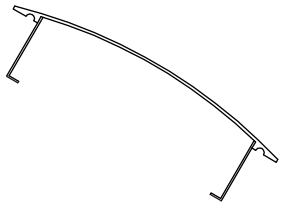

A11=1

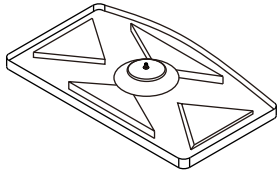

D01=1

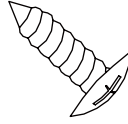

ST4*16=10

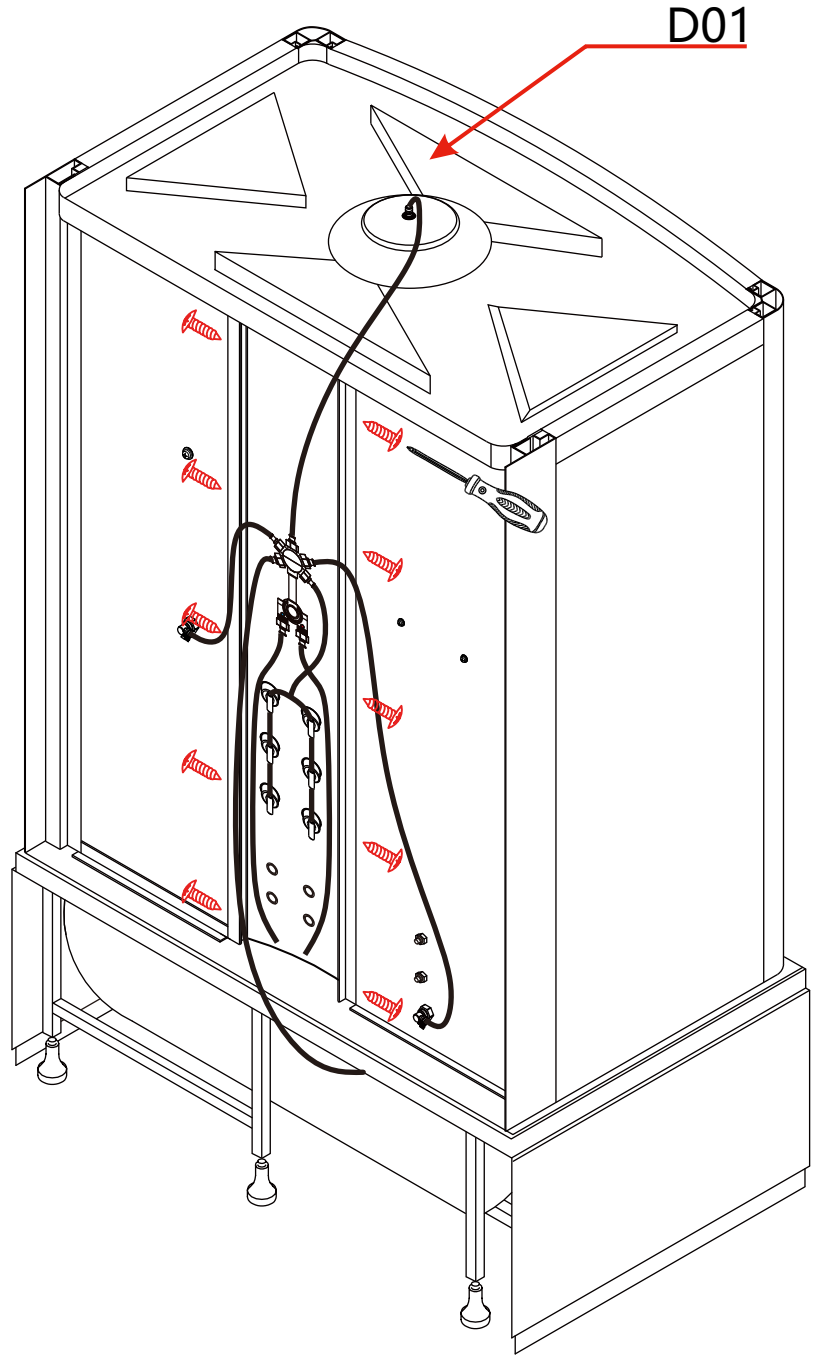
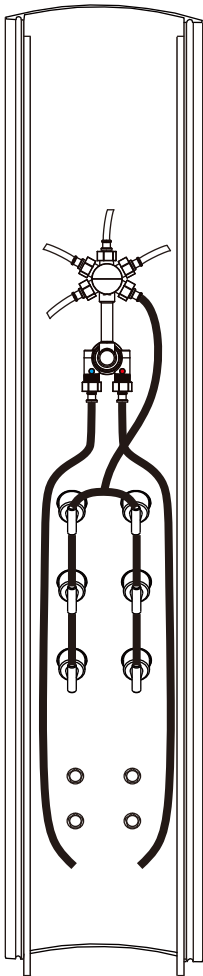
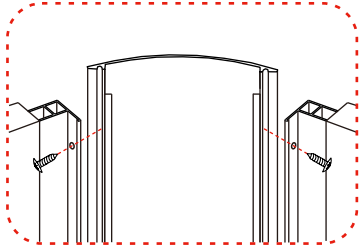
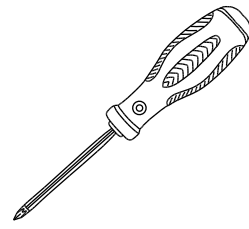

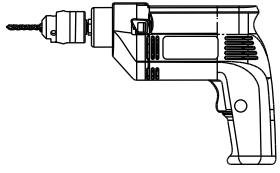
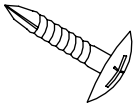

ST4*20=8

